

Cavo unipolare flessibile

disponibile NERO e COLORATO

<u>CODICE</u>	<u>SEZIONE</u>		<u>MT</u>
029590001	0,5	NO 5VK	100
029590002	0,75	NO 5VK	100
029590003	1	NO 7VK	100
029590004	1,5	NO 7VK	100
029590005	2		100
029590006	2,5	NO 7VK	100
029590007	3		100
029590008	4	NO 7VK	100
029590009	6	NO 7VK	100

Cavo unipolare flessibile NO 7VK

<u>CODICE</u>	<u>SEZIONE</u>	<u>MT</u>
029590040	1	100
029590041	1,5	100

Cavo batteria flessibile

disponibile NERO e ROSSO NO 7VK

<u>CODICE</u>	<u>SEZIONE</u>	<u>MT</u>
029590010	10	25
029590011	16	25
029590012	25	25
029590013	35	25
029590014	50	25
029590015	70	25
029590038	90	25

Cavo per saldatrici flessibilissimo

disponibile NERO FF/100

<u>CODICE</u>	<u>SEZIONE</u>	<u>MT</u>
029590077	10	25
029590072	16	25
029590073	25	25
029590074	35	25
029590075	50	25
029590076	70	25

Cavo candela flessibile

<u>CODICE</u>	<u>SEZIONE</u>			<u>MT</u>
029590018	1	Ø 7	rosso	100
029590019	1	Ø 7	nero	100
029590020	1	Ø 7	verde	100
029590021	1	Ø 7	tigrato	100

Cavo multiplo per rimorchio in PVC

<u>CODICE</u>	<u>SEZIONE</u>	<u>MT</u>
029590022	2x1	100
029590059	2x1,5	100
029590023	3x1	100
029590024	4x1	100
029590025	5x1	100
029590026	6x1	100
029590027	7x1	100
029590028	8x1	100
029590029	10x1	100
029590030	12x1	100
029590031	6x1 + 1x2,5	100
029590052	6x1,5 + 1x2,5	100

Cavo multiplo per rimorchio
antifiamma - colore GRIGIO

Cavo flessibile

<u>CODICE</u>	<u>SEZIONE</u>		<u>MT</u>
029590080	2x1	FROR 450/750V	100
029590097	2x1,5		100
029590081	3x1	FROR 450/750V	100
029590098	3x1,5		100
029590082	4x1	FROR 450/750V	100
029590099	4x1,5	FROR	100
029590083	5x1	FROR 450/750V	100
029590100	5x1,5	FROR	100
029590084	6x1	FROR 450/750V	100
029590085	7x1	FROR 300/500V	100
029590101	7x1,5	FROR	100
029590086	8x1	FROR 300/500V	100
029590087	10x1	FROR 300/500V	100
029590088	12x1	FROR 300/500V	100

Cavo multiplo per rimorchio ADR

<u>CODICE</u>	<u>SEZIONE</u>		<u>MT</u>
029590302	2x1		100
029590305	5x1		100
029590306	6x1 + 1x2		100
029590307	9x1 + 1x2		100
029590309	2x4 + 3x1,5	ISO 7638	100

Cavo piattina autoradio

<u>CODICE</u>	<u>SEZIONE</u>		<u>MT</u>
029590050	2x0,35	rosso/nera	100
029590047	2x0,5	rosso/nera	100
029590048	2x0,75	bianco/nera	100
029590049	2x1	blu/nera	100
029590054	2x1	trasparente	100
029590069	2x1,5	giallo/blu	100
029590070	2x2	rosso/nera	100
029590051	4x0,5	rosso/nero/bianco/blu	100
029590071	4x1	rosso/nero/giallo/blu	100

<u>BOBINA</u>		
<u>CODICE</u>	<u>SEZIONE</u>	<u>MT</u>
029690010	0,5	100
029690011	0,75	100
029690012	1	100
029690013	1,5	100
029690014	2	50
029690015	2,5	50
029690016	3	50
029690017	4	25
029690018	6	25
<u>BOBINA CON CAVO BICOLORE</u>		
029690020	1	100
029690021	1,5	100
<u>BOBINA PER PIATTINA AUTORADIO</u>		
029690030	2x0,5	100
029690031	2x0,75	100
029690032	2x1	50
029690050	Bobina vuota per SERVOCAVO	



<u>CODICE</u>	<u>DESCRIZIONE</u>
029690001	Servocavo a parete per 4 bobine (fornito senza bobine)
029690051	Staffa per supporto
029690005	Servocavo a carrello per 24 bobine (fornito senza bobine)

Tubo guaina antifiamma

colore NERO OPACO

<u>CODICE</u>	<u>DESCRIZIONE</u>	<u>MT</u>
029600050	Ø 3	100
029600051	Ø 4	100
029600052	Ø 5	100
029600053	Ø 6	100
029600054	Ø 7	100
029600055	Ø 8	100
029600056	Ø 9	50
029600057	Ø 10	50
029600058	Ø 12	50
029600059	Ø 14	50
029600060	Ø 16	50
029600061	Ø 18	25
029600062	Ø 20	25
029600063	Ø 22	25
029600064	Ø 24	25
029600065	Ø 26	25

Tubo in vipla nero

<u>CODICE</u>	<u>DESCRIZIONE</u>	<u>MT</u>
029600005	Ø 7	100
029600007	Ø 9	100
029600009	Ø 12	100
029600011	Ø 16	100
029600012	Ø 18	100

Tubo spirale

<u>CODICE</u>	<u>DESCRIZIONE</u>	<u>COLORE</u>	<u>MT</u>
029600320	Ø 2 mm	neutro	100
029600321	Ø 4 mm	neutro	100
029600322	Ø 6 mm	neutro	100
029600323	Ø 9 mm	neutro	100
029600324	Ø 12 mm	neutro	100
029600325	Ø 15 mm	neutro	100
029600326	Ø 20 mm	neutro	100
027N10020	Ø 2 mm	nero	100
027N10040	Ø 4 mm	nero	100
027N10060	Ø 6 mm	nero	100
027N10090	Ø 9 mm	nero	100
027N10120	Ø 12 mm	nero	100
027N10150	Ø 15 mm	nero	100
027N10200	Ø 20 mm	nero	100
027N10250	Ø 25 mm	nero	100



Calza retinata elastica per ricostruzione impianti elettrici come originali

<u>CODICE</u>	<u>diam. MIN</u>	<u>diam. MAX</u>	<u>MT</u>
04315069	Ø 5 mm	Ø 12 mm	50
04315070	Ø 8 mm	Ø 17 mm	50
04315071	Ø 14 mm	Ø 26 mm	50

Tubo corrugato APERTO

colore: NERO RIGA blu
 temperatura esercizio: 30 C + 125 C
 materiale: POLIPROPILENE

<u>CODICE</u>	<u>DIAMETRO</u>	<u>MT</u>
029600300	Ø 6 mm	100
029600301	Ø 9 mm	100
029600302	Ø 11 mm	100
029600303	Ø 13 mm	100
029600304	Ø 16 mm	100
029600305	Ø 19 mm	100

Tubo corrugato CHIUSO

<u>CODICE</u>	<u>DIAMETRO</u>	<u>MT</u>
029600306	Ø 7,5 mm	50
029600307	Ø 10 mm	50
029600308	Ø 12 mm	50
029600309	Ø 17 mm	50
029600310	Ø 22 mm	50
029600311	Ø 29 mm	50

Guaina TERMORESTRINGENTE

<u>CODICE</u>	<u>diam. prima del restringimento</u>	<u>diam. dopo del restringimento</u>	<u>spessore dopo del restringimento</u>
029600098	2,4	1,2	0,51
029600099	3,2	1,6	0,51
029600100	4,8	2,4	0,52
029600101	6,4	3,2	0,65
029600102	9,5	4,8	0,65
029600103	12,7	6,4	0,65
029600104	19	9,5	0,77

Guaina in poliolefina a parete doppia con ADESIVO INTERNO

<u>CODICE</u>	<u>diam. prima del restringimento</u>	<u>diam. dopo del restringimento</u>	<u>spessore dopo del restringimento</u>
	2,4	1,2	0,51
	3,2	1,6	0,51
	4,8	2,4	0,52
	6,4	3,2	0,65
	9,5	4,8	0,65
	12,7	6,4	0,65
	19	9,5	0,77
	25,4	12,7	1,2

PASSO 5 F480

CODICE	SEZIONE CAVO	SPESSORE
0091101940	0,5÷1,5	0,35

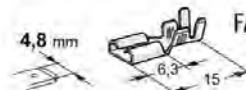
FASTON F480

CODICE	SEZIONE CAVO	SPESSORE
0091301391	0,5÷1	0,33

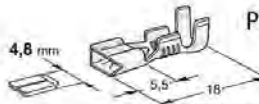
PASSO 5 F480

CODICE	SEZIONE CAVO	SPESSORE
0091101970	0,5÷1,5	0,4

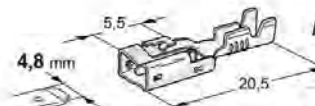
ANTISF F480

CODICE	SEZIONE CAVO	SPESSORE
0091107030	0,35÷1	0,4

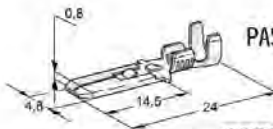
PASSO 5 M480 C/DENTE

CODICE	SEZIONE CAVO	SPESSORE
0091101950	0,5÷1,5	0,4

FASTON F630 C/DENTE

CODICE	SEZIONE CAVO	SPESSORE
0091101650	1÷2,5	0,35
0091701651	2,5÷6	0,35

FASTON F280 C/DENTE

CODICE	SEZIONE CAVO	SPESSORE
0091101700	0,5÷1	0,25

FASTON F630

CODICE	SEZIONE CAVO	SPESSORE
0091301402	0,3÷0,8	0,4
0091701655	1÷2,5	0,35
0091101400	1÷2,5	0,4

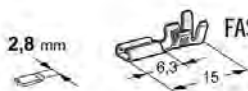
FASTON F280

CODICE	SEZIONE CAVO	SPESSORE
0091301390	0,5÷1	0,3

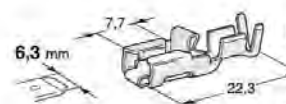
ANTISF F630

CODICE	SEZIONE CAVO	SPESSORE
0091107000	0,5÷1,5	0,4
0091107010	2,5÷4	0,4

FASTON F480 C/DENTE

CODICE	SEZIONE CAVO	SPESSORE
0091101710	0,5÷1	0,32

FASTON F950 C/DENTE

CODICE	SEZIONE CAVO	SPESSORE
0091101720	6÷10	0,4

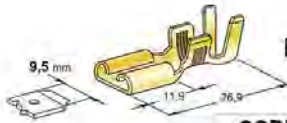
FASTON F950

CODICE	SEZIONE CAVO	SPESSORE
0091301420	2÷4	0,5

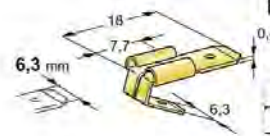
FASTON 630 3VIE

CODICE	SPESSORE
0091301500	0,4

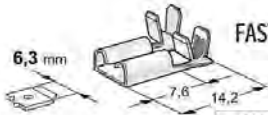
FASTON F630 FLAG

CODICE	SEZIONE CAVO	SPESSORE
0091701530	0,5÷1,5	0,4

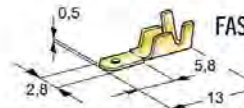
FASTON M280

CODICE	SEZIONE CAVO	SPESSORE
0091301418	0,5÷1	0,5

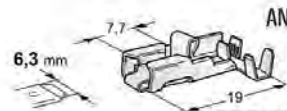
ANTISF F630 FLAG

CODICE	SEZIONE CAVO	SPESSORE
0091107020	1÷2,5	0,4

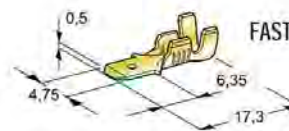
FASTON M480

CODICE	SEZIONE CAVO	SPESSORE
0091301417	0,5÷1	0,5

FASTON F800 FLAG C/DENTE

CODICE	SEZIONE CAVO	SPESSORE
0091101680	1÷2,5	0,4

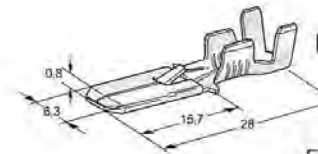
FASTON M630 C/DENTE

CODICE	SEZIONE CAVO	SPESSORE
0091101660	1÷2,5	0,4
0091101662	4÷6	0,4

FASTON F800 FLAG

CODICE	SEZIONE CAVO	SPESSORE
0091951145	1÷2,5	0,4

FASTON M630 C/DENTE

CODICE	SEZIONE CAVO	SPESSORE
0091301665	1÷2,5	0,4

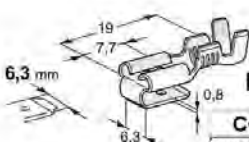
FASTON 630 2VIE

CODICE	SEZIONE CAVO	SPESSORE
0091301501	0,8÷2,5	0,4

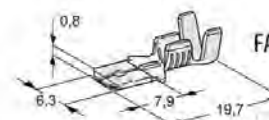
FASTON M630

CODICE	SEZIONE CAVO	SPESSORE
0091301411	0,5÷1	0,4
0091301412	1÷2,5	0,4

L13 M4

CODICE	SEZIONE CAVO	SPESSORE
0091201000	1÷2,5	0,4

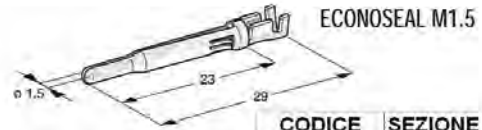
ECONOSEAL M1.5

CODICE	SEZIONE CAVO	SPESSORE
0091201230	0,5÷1,5	0,3

L17 F4

CODICE	SEZIONE CAVO	SPESSORE
0091201070	1÷2,5	0,4

ECONOSEAL F1.5

CODICE	SEZIONE CAVO	SPESSORE
0091201220	0,5÷1,5	0,3

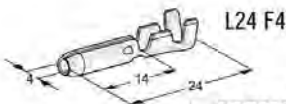
L24 F4

CODICE	SEZIONE CAVO	SPESSORE
0091201100	0,5÷2,5	0,4

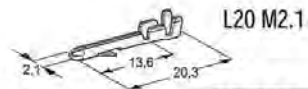
L20 M2.1

CODICE	SEZIONE CAVO	SPESSORE
0091201150	0,5÷1	0,32

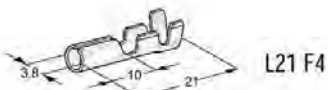
L21 F4

CODICE	SEZIONE CAVO	SPESSORE
0091201110	0,5÷2,5	0,4

L17 F2

CODICE	SEZIONE CAVO	SPESSORE
0091201160	0,5÷1	0,32

MATE-N-LOCK M2

CODICE	SEZIONE CAVO	SPESSORE
0091201210	0,5÷2,5	0,3

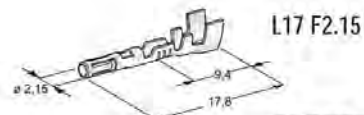
L17 F2.15

CODICE	SEZIONE CAVO	SPESSORE
0091201180	0,3+0,5	0,125

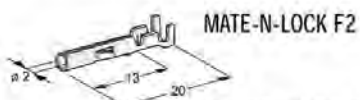
MATE-N-LOCK F2

CODICE	SEZIONE CAVO	SPESSORE
0091201200	0,5÷2,5	0,3

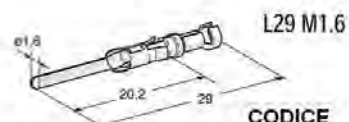
L29 M1.6

CODICE	SEZIONE CAVO	SPESSORE
0091107960	0,5÷1	0,35

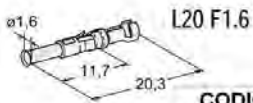
L20 F1.6

CODICE	SEZIONE CAVO	SPESSORE
0091107970	0,5+1	0,35

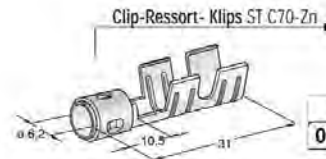
Clip-Ressort- Klips ST C70-Zn

CODICE	SEZIONE CAVO	SPESSORE
0091400850	7	0,5

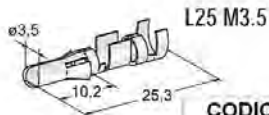
L25 M3.5

CODICE	SEZIONE CAVO	SPESSORE
0091107980	2,5÷6	0,35
0091107990	1÷2,5	0,35

Clip-Ressort- Klips ST C70-Zn

CODICE	SEZIONE CAVO	SPESSORE
0091400862	7	0,5

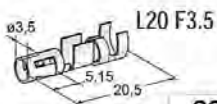
L20 F3.5

CODICE	SEZIONE CAVO	SPESSORE
0091108000	2,5+6	0,35

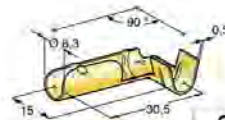

CODICE	SEZIONE CAVO	SPESSORE
0091200880	7	0,5

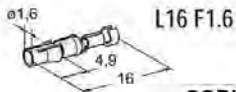
L16 F1.6

CODICE	SEZIONE CAVO	SPESSORE
0091108100	0,3÷0,6	0,3

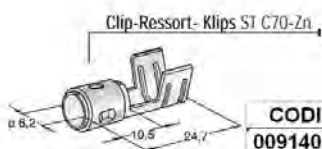

CODICE	SEZIONE CAVO	SPESSORE
0091400910	7	0,5

Clip-Ressort- Klips ST C70-Zn

CODICE	SEZIONE CAVO	SPESSORE
0091400860	7	0,5

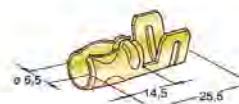

CODICE	SEZIONE CAVO	SPESSORE
0091400920	7	0,5

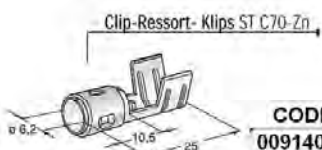
Clip-Ressort- Klips ST C70-Zn

CODICE	SEZIONE CAVO	SPESSORE
0091400865	7	0,5

SENZA VITE

CODICE	SEZIONE CAVO	SPESSORE
0091900830	7	0,5

VITE

CODICE	SEZIONE CAVO	SPESSORE
0091200831	7	0,5

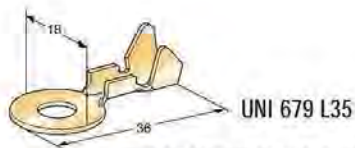

CODICE	SEZIONE CAVO	SPESSORE	VITE
0091602550	4÷6	0,7	M10

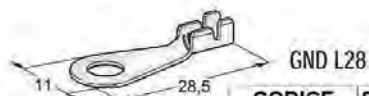

CODICE	SEZIONE CAVO	SPESSORE	VITE
0091606740	0,5÷1,5	0,6	M5

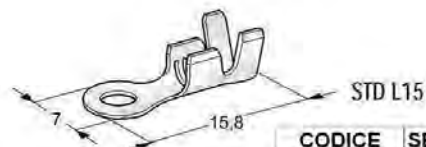

CODICE	SEZIONE CAVO	SPESSORE	VITE
0091702951	0,5÷2	0,5	M2
0091702950	0,5÷2	0,5	M3



CODICE	SEZIONE CAVO	SPESSORE	VITE
0091106720	1÷2,5	0,8	M6
0091106700	4÷6	0,8	M6
0091106750	8÷10	0,8	M6
0091106730	1÷2,5	0,8	M8
0091106710	4÷6	0,8	M8
0091106760	8÷10	0,8	M8

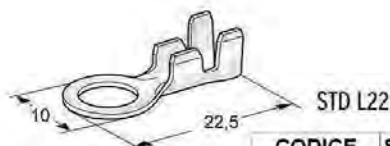

CODICE	SEZIONE CAVO	SPESSORE	VITE
0091602970	1÷2	0,6	M4
0091602980	1÷2	0,6	M5
0091602981	1÷2	0,6	M6

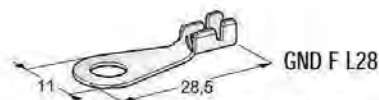

CODICE	SEZIONE CAVO	SPESSORE	VITE
0091706741	0,5÷1,5	0,6	M5

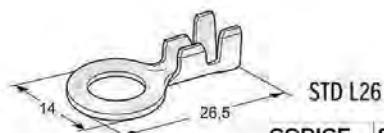

CODICE	SEZIONE CAVO	SPESSORE	VITE
0091602990	2÷2,5	0,8	M6
0091603000	2÷4	0,8	M8

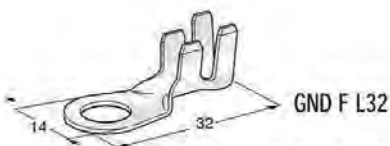

CODICE	SEZIONE CAVO	SPESSORE	VITE
0091706721	1÷2,5	0,8	M6
0091706701	3÷6	0,8	M6
0091706731	1÷2,5	0,8	M8
0091706711	3÷6	0,8	M8



CODICE	SEZIONE CAVO	SPESSORE	VITE
0091609000	25÷40	1,5	M6

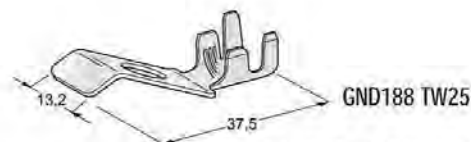

CODICE	SEZIONE CAVO	SPESSORE	VITE
0091708150	2,5÷4	0,8	M8

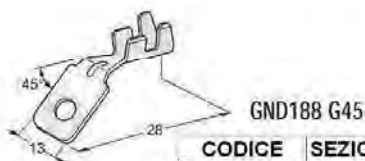

CODICE	SEZIONE CAVO	SPESSORE	VITE
0091708160	2,5÷6	0,8	M5

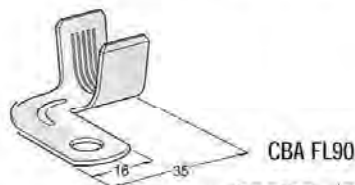

CODICE	SEZIONE CAVO	SPESSORE	VITE
0091608170	10÷20	1,5	M8
0091604300	25÷35	1,5	M6
0091608210	25÷35	1,5	M8
0091708230	50÷70	1,5	M8



CODICE	SEZIONE CAVO	SPESSORE	VITE
0091708325	20÷35	1,8	M6
0091708320	25÷35	1,8	M8
0091608321	20÷40	1,8	M8
0091708315	50÷70	1,8	M6
0091708310	50÷70	1,8	M8

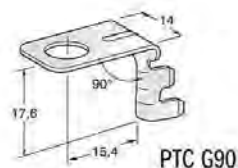

CODICE	SEZIONE CAVO	SPESSORE	VITE
0091608500	2,5÷4	0,8	M8

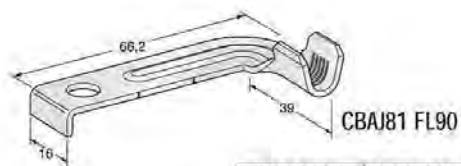

CODICE	SEZIONE CAVO	SPESSORE	VITE
0091609200	10÷20	1,5	M8

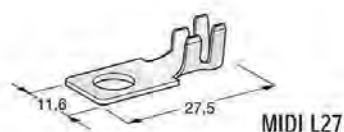

CODICE	SEZIONE CAVO	SPESSORE	VITE
0091108240	2,5÷4	0,8	M5
0091108245	6÷8	0,8	M5
0091708246	6÷8	0,8	M6

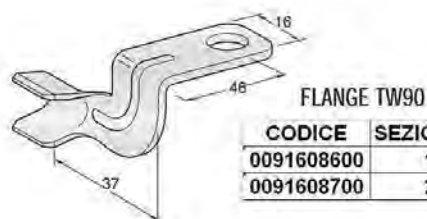

CODICE	SEZIONE CAVO	SPESSORE	VITE
0091608600	10÷20	1,5	M8
0091608700	25÷35	1,5	M8



CODICE	SEZIONE CAVO	SPESSORE	VITE
0091708250	10÷16	0,8	M5

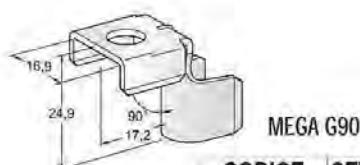

CODICE	SEZIONE CAVO	SPESSORE	VITE
0091608180	10÷20	1,5	M8
0091608190	25÷35	1,5	M8



CODICE	SEZIONE CAVO	SPESSORE	VITE
0091705835	10÷20	1,5	M5

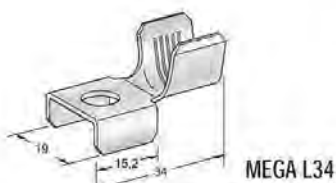

CODICE	SEZIONE CAVO	SPESSORE	VITE
0091108110	10÷20	1,2	M8
0091108120	25÷35	1,2	M8

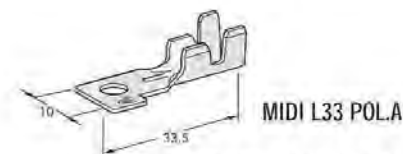

CODICE	SEZIONE CAVO	SPESSORE	VITE
0091705616	2,5÷4	0,8	M5
0091705715	6÷8	0,8	M5

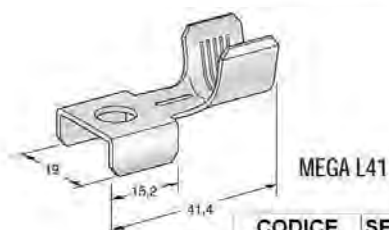

CODICE	SEZIONE CAVO	SPESSORE	VITE
0091608196	25÷40	1,5	M8

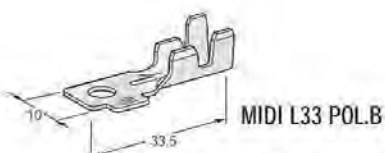

CODICE	SEZIONE CAVO	SPESSORE	VITE
0091705725	6÷8	0,8	M5

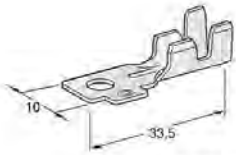
MIDI L33 POL.D

CODICE	SEZIONE CAVO	SPESSORE	VITE
0091705745	6÷8	0,8	M5

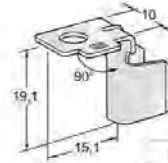
MIDI G90 POL.B

CODICE	SEZIONE CAVO	SPESSORE	VITE
0091605820	10÷16	1,5	M5
0091605920	25÷35	1,5	M5

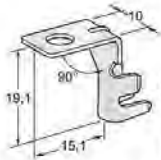
MIDI G90 UNI

CODICE	SEZIONE CAVO	SPESSORE	VITE
0091605600	2,5÷4	0,8	M5
0091605700	6÷8	0,8	M5

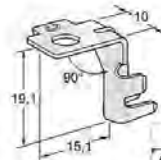
MIDI G90 POL.C

CODICE	SEZIONE CAVO	SPESSORE	VITE
0091605630	2,5÷4	0,8	M5
0091605730	6÷8	0,8	M5

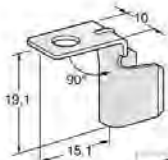
MIDI G90 UNI

CODICE	SEZIONE CAVO	SPESSORE	VITE
0091605800	10÷16	1,5	M5
0091605900	25÷35	1,5	M5

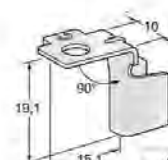
MIDI G90 POL.C

CODICE	SEZIONE CAVO	SPESSORE	VITE
0091605830	10÷16	1,5	M5
0091605930	25÷35	1,5	M5

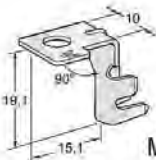
MIDI G90 POL.A

CODICE	SEZIONE CAVO	SPESSORE	VITE
0091605610	2,5÷4	0,8	M5
0091605710	6÷8	0,8	M5

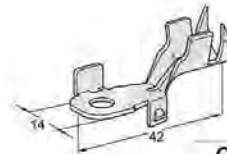
RVS-A L42

CODICE	SEZIONE CAVO	SPESSORE	VITE
0091706900	2,5÷4	0,8	M6
0091706910	6÷8	1,0	M6
0091706920	10÷16	1,2	M6

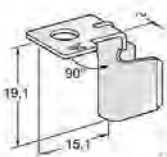
MIDI G90 POL.A

CODICE	SEZIONE CAVO	SPESSORE	VITE
0091605810	10÷16	1,5	M5
0091605910	25÷35	1,5	M5

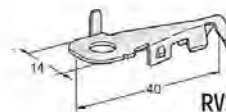
RVS-B L40

CODICE	SEZIONE CAVO	SPESSORE	VITE
0091706930	2,5÷4	0,8	M6
0091706940	6÷8	1,0	M6

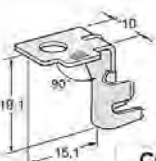
MIDI G90 POL.B

CODICE	SEZIONE CAVO	SPESSORE	VITE
0091605620	2,5÷4	0,8	M5
0091605720	6÷8	0,8	M5

SMT-A L39

CODICE	SEZIONE CAVO	SPESSORE	VITE
0091706880	6÷8	1,0	M6
0091606890	10÷16	1,2	M6

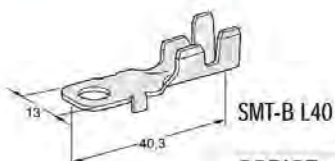

CODICE	SEZIONE CAVO	SPESSORE	VITE
0091606600	2,5÷4	0,8	M6



CODICE	SEZIONE CAVO	SPESSORE	VITE
0091606982	25÷40	1,2	M6

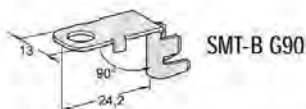

CODICE	SEZIONE CAVO	SPESSORE	VITE
0091606790	2,5÷4	0,8	M6



CODICE	SEZIONE CAVO	SPESSORE	VITE
0091708220	10÷20	1,5	M10
0091708200	25÷35	1,5	M10

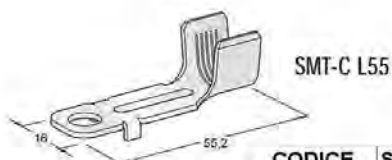

CODICE	SEZIONE CAVO	SPESSORE	VITE
00916006796	50÷70	1,5	M8

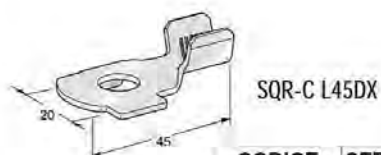

CODICE	SEZIONE CAVO	SPESSORE	VITE
0091708185	10÷20	1,5	M10
0091708260	25÷40	1,5	M10

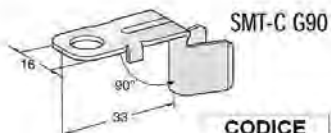

CODICE	SEZIONE CAVO	SPESSORE	VITE
0091606775	6÷8	1,2	M6
0091606770	10÷20	1,2	M6
0091606500	25÷40	1,2	M6
0091606780	10÷20	1,2	M8
0091606785	25÷40	1,2	M8



CODICE	SEZIONE CAVO	SPESSORE	VITE
0091708195	10÷20	1,5	M10
0091708270	25÷40	1,5	M10

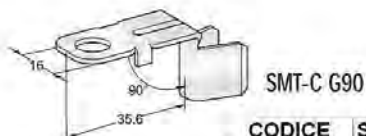

CODICE	SEZIONE CAVO	SPESSORE	VITE
0091606795	50÷70	1,5	M8

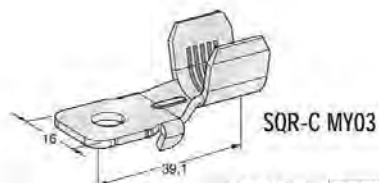

CODICE	SEZIONE CAVO	SPESSORE	VITE
0091706975	10÷20	1,5	M6
0091706977	25÷40	1,5	M6



CODICE	SEZIONE CAVO	SPESSORE	VITE
0091706970	10÷20	1,2	M6
0091706980	25÷35	1,2	M6
0091606981	25÷40	1,5	M6
0091706950	10÷20	1,2	M8
0091706960	25÷35	1,2	M8
0091606990	25÷40	1,5	M8

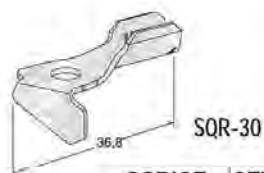

CODICE	SEZIONE CAVO	SPESSORE	VITE
0091608340	6÷8	1,5	M6
0091608345	10÷20	1,5	M6

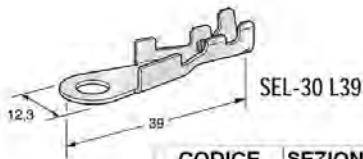

CODICE	SEZIONE CAVO	SPESSORE	VITE
0091708350	2,5÷5	0,8	M6

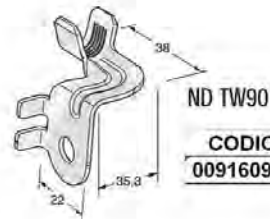

CODICE	SEZIONE CAVO	SPESSORE	VITE
0091609100	25÷40	1,5	M8

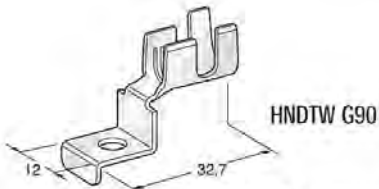

CODICE	SEZIONE CAVO	SPESSORE	VITE
0091607300	8÷15	1	M5

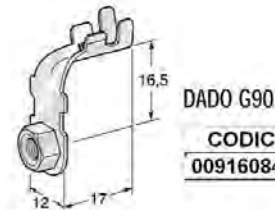

CODICE	SEZIONE CAVO	SPESSORE	VITE
0091608400	2,5÷5	1,0	M5

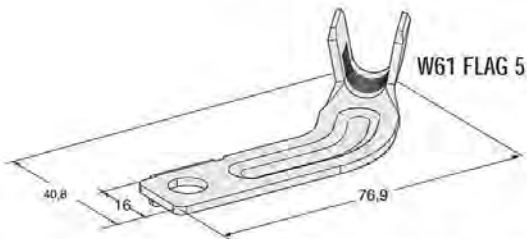

CODICE	SEZIONE CAVO	SPESSORE	VITE
0091609600	25÷50	1,8	M8



CODICE	SEZIONE CAVO	SPESSORE	VITE
0091608420	2,5÷5	1,2	M5

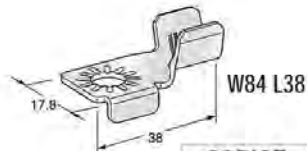

CODICE	SEZIONE CAVO	SPESSORE	VITE
0091608800	10÷25	1,5	M8



CODICE	SEZIONE CAVO	SPESSORE	VITE
0091608415	4÷7	1,0	M5



CODICE	SEZIONE CAVO	SPESSORE	VITE
0091608901	25÷41	1,5	M8

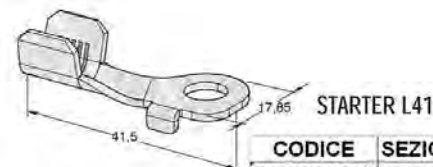

CODICE	SEZIONE CAVO	SPESSORE	VITE
0091708360	10÷20	1,5	M8
0091708370	25÷40	1,5	M8



CODICE	SEZIONE CAVO	SPESSORE	VITE
0091608911	10÷25	1,5	M8

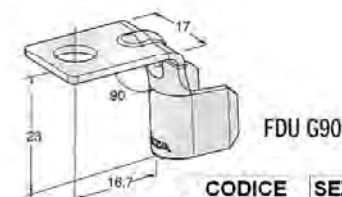

CODICE	SEZIONE CAVO	SPESSORE	VITE
0091608380	25÷40	1,5	M8

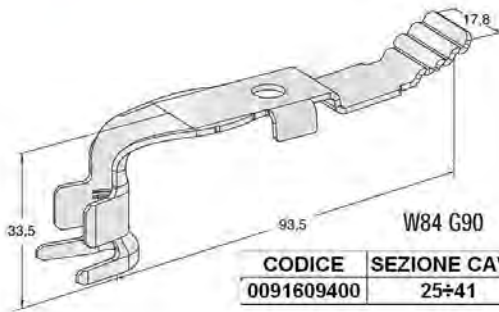

CODICE	SEZIONE CAVO	SPESSORE	VITE
0091609400	25÷41	1,5	M8



CODICE	SEZIONE CAVO	SPESSORE	VITE
0091605040	75	2	M13

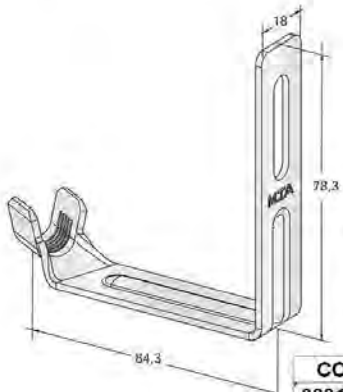

CODICE	SEZIONE CAVO	SPESSORE	VITE
0091609500	25÷40	1,8	M8

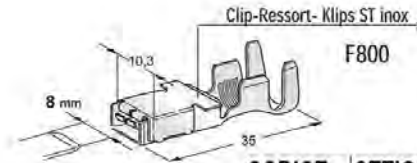

CODICE	SEZIONE CAVO	SPESSORE
0091107650	1,5÷2,5	0,5
0091107660	4÷6	0,5
0091107670	8÷10	0,5
0091107671	16	0,5

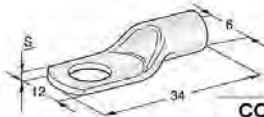

CODICE	SEZIONE CAVO	SPESSORE	VITE
0061605000	16	2	M6
0091605100	16	2	M8



CODICE	SEZIONE CAVO	SPESSORE
0091107675	2,5÷4	0,8
0091107685	6÷8	0,8
0091107690	10÷16	0,8



CODICE	SEZIONE CAVO	SPESSORE	VITE
0091605010	25	2	M8
0091605110	25	2	M10

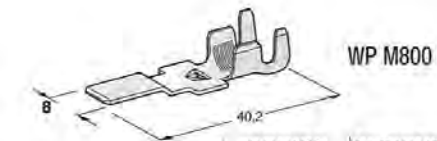

CODICE	SEZIONE CAVO	SPESSORE
0091107700	2,5÷4	0,8
0091107710	6÷8	0,8
0091107720	10÷16	0,8



CODICE	SEZIONE CAVO	SPESSORE	VITE
0091605021	35	2	M8
0091605020	35	2	M10

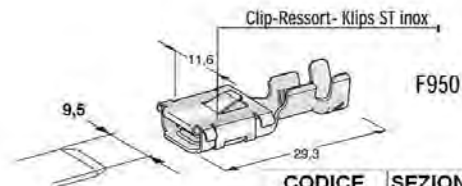

CODICE	SEZIONE CAVO	SPESSORE
0091107740	2,5÷4	0,6
0091107741	6÷8	0,6

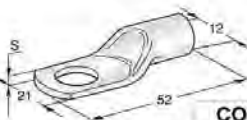

CODICE	SEZIONE CAVO	SPESSORE	VITE
0091605030	50	2	M11

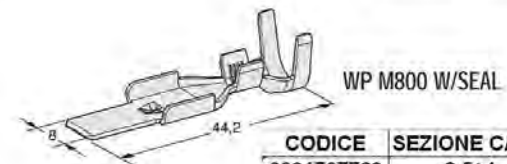

CODICE	SEZIONE CAVO	SPESSORE
0091707760	2,5÷4	0,8
0091707770	6÷8	0,8
0091707780	10÷16	0,8

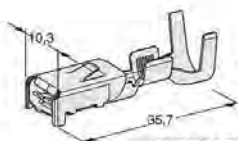
WP F800 W/SEAL

CODICE	SEZIONE CAVO	SPESSORE
0091707400	1,5÷2,5	0,5
0091707410	3÷6	0,5
0091707420	7÷10	0,5

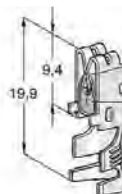

UNI F630 C/CLIP

Clip-Ressort- Klips ST inox

CODICE	SEZIONE CAVO	SPESSORE
0091107920	0,5÷1,5	0,4
0091107930	2÷3	0,4
0091107940	4÷6	0,4

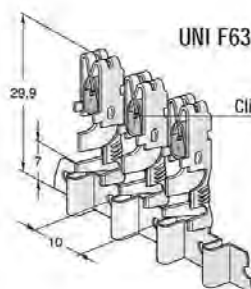

CODICE	SEZIONE CAVO
009450781	3,4÷4,33



UNI F630 BUS-BAR C/CLIP

Clip-Ressort- Klips ST inox

CODICE	SEZIONE CAVO	SPESSORE
0091707932	2÷3	0,4
0091707942	4÷6	0,4

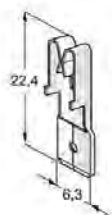

CODICE	SEZIONE CAVO
0094550782	4,9÷5,7

UNI F630

CODICE	SPESSORE
0091107501	0,4

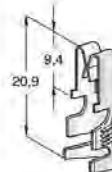

TAPPO CHIUSURA

CODICE
0094550784

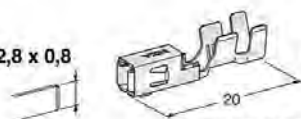

UNI F630

CODICE	SEZIONE CAVO	SPESSORE
0091107900	0,5÷1,5	0,4
0091707902	2÷3	0,4
0091107901	4÷6	0,4

2,8 x 0,8

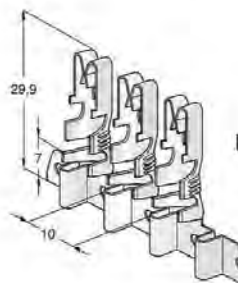

MINI F280

CODICE	SEZIONE CAVO	SPESSORE
0091108330	0,35÷0,75	0,30
0091108331	1÷2	0,30
0091108332	2,5÷4	0,30

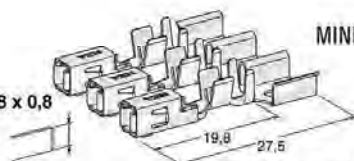

UNI F630 BUS-BAR

CODICE	SEZIONE CAVO	SPESSORE
0091707910	0,5÷1,5	0,4
0091707912	2÷3	0,4
0091707911	4÷6	0,4

2,8 x 0,8

MINI F280 BUS-BAR

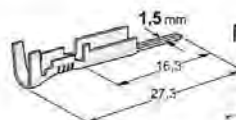
CODICE	SEZIONE CAVO	SPESSORE
0091708335	1÷2	0,30
0091708336	2,5÷4	0,30

METRIPACK M150

CODICE	SEZIONE CAVO	SPESSORE
0091105510	0,5÷1	0,4

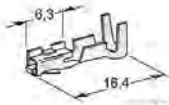
METRIPACK F150

CODICE	SEZIONE CAVO	SPESSORE
0091105500	0,5÷1	0,4

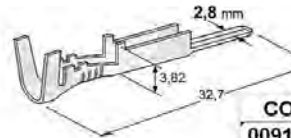
METRIPACK M280

CODICE	SEZIONE CAVO	SPESSORE
0091104500	1÷2,5	0,4



CODICE	SEZIONE CAVO
0094407530	0,5÷1

METRIPACK F280

CODICE	SEZIONE CAVO	SPESSORE
0091104510	1÷2,5	0,4

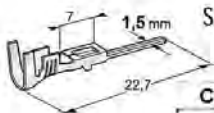
S-SEAL M150

CODICE	SEZIONE CAVO	SPESSORE
0091105550	1÷1,5	0,32



CODICE	SEZIONE CAVO
0094407510	1÷2,5

S-SEAL F150

CODICE	SEZIONE CAVO	SPESSORE
0091105560	1÷1,5	0,3

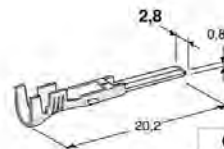
070DTB M280

CODICE	SEZIONE CAVO	SPESSORE
0091108420	1÷1,5	0,4



CODICE	SEZIONE CAVO
0094407740	0,5÷1

070DTB F280

CODICE	SEZIONE CAVO	SPESSORE
0091108410	1÷1,5	0,4

TAPPO CHIUSURA

CODICE
0094407750

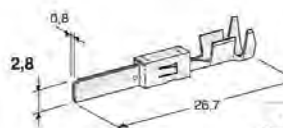
JPT-WP M280

CODICE	SEZIONE CAVO	SPESSORE
0091108290	0,5÷1,5	0,32
0091108300	1,5÷2,5	0,32

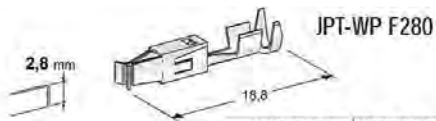

CODICE	SEZIONE CAVO	SPESSORE
0091108260	0,5÷1	0,32
0091108270	1÷2,5	0,32

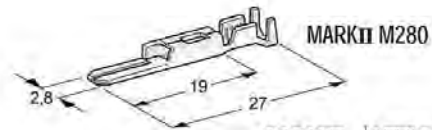

CODICE	SEZIONE CAVO	SPESSORE
0091102010	0,5÷1,5	0,4



CODICE	SEZIONE CAVO
0094510662	0,5÷1

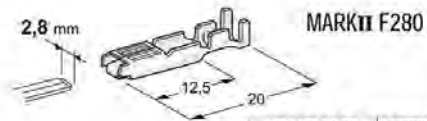

CODICE	SEZIONE CAVO	SPESSORE
0091102000	0,5÷1,5	0,4



CODICE	SEZIONE CAVO
0094410658	1,5÷2,5

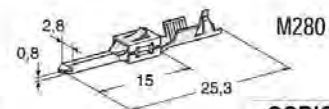

CODICE	SEZIONE CAVO	SPESSORE
0091108030	0,5÷1	0,3



CODICE	SEZIONE CAVO	SPESSORE
0091105650	0,75÷1,5	0,30



CODICE	SEZIONE CAVO	SPESSORE
0091108050	0,5÷1	0,3

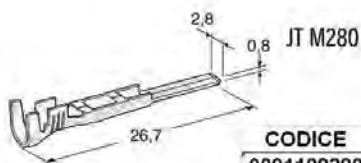

CODICE	SEZIONE CAVO	SPESSORE
0091108280	0,35÷1	0,32



CODICE	SEZIONE CAVO	SPESSORE
0091108060	0,5÷1	0,38



CODICE	SEZIONE CAVO	SPESSORE
0091107210	0,5÷1,5	0,32
0091107211	1,5÷2,5	0,32

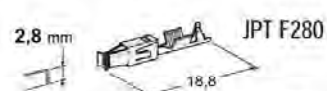

CODICE	SEZIONE CAVO	SPESSORE
0091105615	0,2÷0,5	0,32
0091105620	0,5÷1	0,32
0091105630	1,5÷2,5	0,32

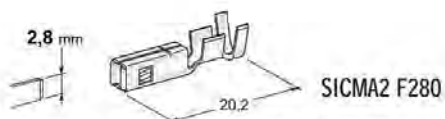
SICMA2 F280

CODICE	SEZIONE CAVO	SPESSORE
0091105660	0,35±0,75	0,35
0091105670	1±2,5	0,35

MKF F150

CODICE	SEZIONE CAVO	SPESSORE
0091108020	0,5±1	0,3

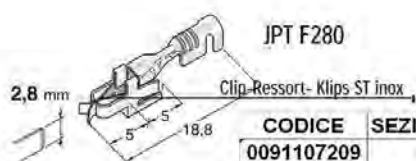
JPT F280

CODICE	SEZIONE CAVO	SPESSORE
0091107209	0,5±1	0,4
0091107212	1±2,5	0,4

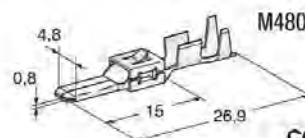
M480

CODICE	SEZIONE CAVO	SPESSORE
0091108040	1,5±2,5	0,38

FANALI POST. VW-FIAT

CODICE	SEZIONE CAVO	SPESSORE
0091101800	0,35±1	0,3

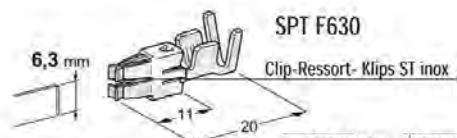
SPT F630

CODICE	SEZIONE CAVO	SPESSORE
0091102050	2,5±4	0,4

FANALI POST. C/CIRCUITI STAMPATI

CODICE	SEZIONE CAVO	SPESSORE
0091101920	1±2,5	0,3

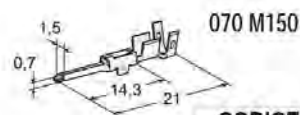
070 M150

CODICE	SEZIONE CAVO	SPESSORE
0091108080	0,75±1,5	0,3

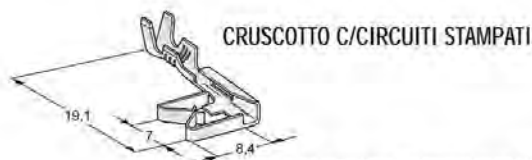
CRUSCOTTO C/CIRCUITI STAMPATI

CODICE	SEZIONE CAVO	SPESSORE
0091101930	0,5±1,5	0,3

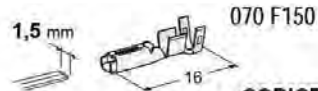
070 F150

CODICE	SEZIONE CAVO	SPESSORE
0091107260	0,3±0,5	0,32
0091108070	0,75±1,5	0,32

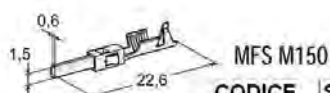
MFS M150

CODICE	SEZIONE CAVO	SPESSORE
0091108010	0,5±1	0,3

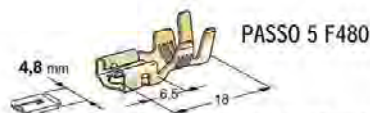
PASSO 5 F480

CODICE	SEZIONE CAVO	SPESSORE
0091301910	0,5±1,5	0,28

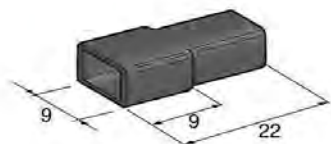

CODICE	DESCRIZIONE
0094410070	copriterminale femmina NERO

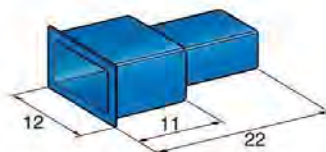

CODICE	DESCRIZIONE
0094410081	copriterminale maschio BLU

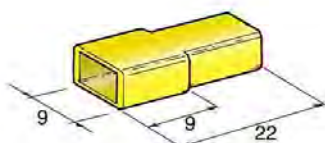

CODICE	DESCRIZIONE
0094410072	copriterminale femmina GIALLO

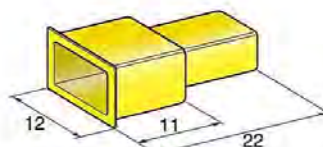

CODICE	DESCRIZIONE
0094410082	copriterminale maschio GIALLO



CODICE	DESCRIZIONE
0094410073	copriterminale femmina BLU

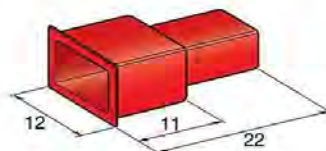

CODICE	DESCRIZIONE
0094410084	copriterminale maschio ROSSO



CODICE	DESCRIZIONE
0094410074	copriterminale femmina ROSSO

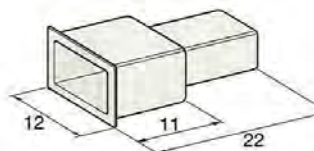

CODICE	DESCRIZIONE
0094410086	copriterminale maschio NEUTRO

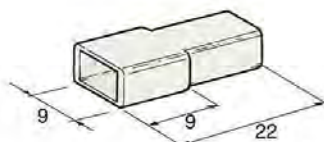

CODICE	DESCRIZIONE
0094410076	copriterminale femmina NEUTRO



CODICE	DESCRIZIONE
0094410065	copriterminale femmina NEUTRO

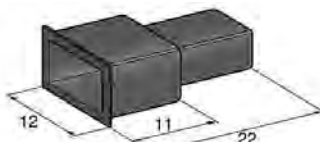

CODICE	DESCRIZIONE
0094410080	copriterminale maschio NERO

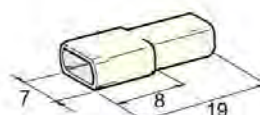

CODICE	DESCRIZIONE
0094410068	copriterminale maschio NERO



CODICE	SEZIONE CAVO	DIAM.	SPESSORE
0091853050	0,25÷1	3,2	0,75
0091853060	0,25÷1	3,7	0,75
0091853070	0,25÷1	4,3	0,75
0091853150	0,25÷1	5,3	0,75
0091853200	0,25÷1	6,4	0,75
0091853250	0,25÷1	8,4	0,75

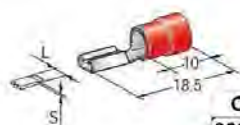

CODICE	SEZIONE CAVO	S	SPESSORE
0091850200	0,25÷1	0,5	0,3
0091850400	0,25÷1	0,8	0,3



CODICE	SEZIONE CAVO	DIAM.	SPESSORE
0091857050	1÷2,5	3,2	0,8
0091857060	1÷2,5	3,7	0,8
0091857100	1÷2,5	4,3	0,8
0091857150	1÷2,5	5,3	0,8
0091857200	1÷2,5	6,4	0,8
0091857250	1÷2,5	8,4	0,8



CODICE	SEZIONE CAVO	S	SPESSORE
0091854200	1÷2,5	0,5	0,3
0091854400	1÷2,5	0,8	0,3



CODICE	SEZIONE CAVO	DIAM.	SPESSORE
0091863100	2,5÷6	4,3	1
0091863150	2,5÷6	5,3	1
0091863200	2,5÷6	6,4	1
0091863250	2,5÷6	8,4	1
0091863300	2,5÷6	10,4	1

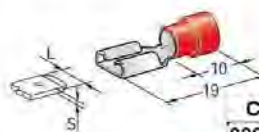

CODICE	SEZIONE CAVO	S	SPESSORE
0091850500	0,25÷1	0,5	0,4
0091850300	0,25÷1	0,8	0,4



CODICE	SEZIONE CAVO	DIAM.	SPESSORE
0091865060	0,25÷1	3,7	0,75
0091865100	0,25÷1	4,3	0,75
0091865200	0,25÷1	5,3	0,75

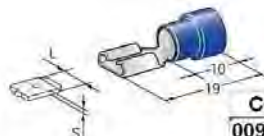

CODICE	SEZIONE CAVO	S	SPESSORE
0091854500	1÷2,5	0,5	0,4
0091854300	1÷2,5	0,8	0,4



CODICE	SEZIONE CAVO	DIAM.	SPESSORE
0091866000	1÷2,5	3,2	0,8
0091866050	1÷2,5	3,7	0,8
0091866100	1÷2,5	4,3	0,8
0091866200	1÷2,5	5,3	0,8
0091866300	1÷2,5	6,4	0,8



CODICE	SEZIONE CAVO	SPESSORE
0091851400	0,25÷1	0,4

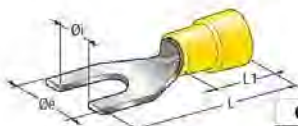

CODICE	SEZIONE CAVO	DIAM.	SPESSORE
0091867000	2,5÷6	4,3	1
0091867100	2,5÷6	5,3	1
0091867200	2,5÷6	6,4	1



CODICE	SEZIONE CAVO	SPESSORE
0091855400	1÷2,5	0,4

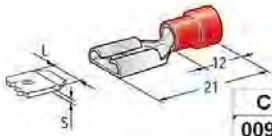

CODICE	SEZIONE CAVO	SPESSORE
0091851000	0,25+1	0,4

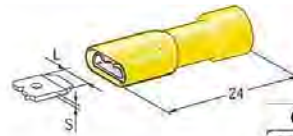

CODICE	SEZIONE CAVO	SPESSORE
0091860500	2,5+6	0,4

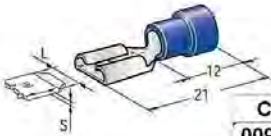

CODICE	SEZIONE CAVO	SPESSORE
0091855000	1+2,5	0,4



CODICE	SEZIONE CAVO	SPESSORE
0091850450	0,25+1	0,8

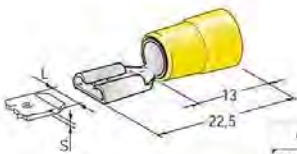

CODICE	SEZIONE CAVO	SPESSORE
0091861000	2,5+6	0,4



CODICE	SEZIONE CAVO	SPESSORE
0091850550	0,25+1	0,5
0091850350	0,25+1	0,8

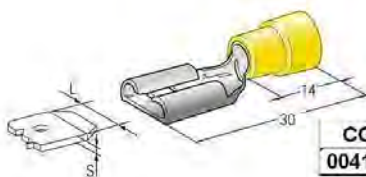

CODICE	SEZIONE CAVO	SPESSORE
0041863000	2,5+6	0,4



CODICE	SEZIONE CAVO	SPESSORE
0091854550	1+2,5	0,5
0091854350	1+2,5	0,8



CODICE	SEZIONE CAVO	SPESSORE
0091851500	0,25+1	0,4



CODICE	SEZIONE CAVO	SPESSORE
0091852000	0,25+1	0,8



CODICE	SEZIONE CAVO	SPESSORE
0091855500	1+2,5	0,4



CODICE	SEZIONE CAVO	SPESSORE
0091856000	1+2,5	0,8



CODICE	SEZIONE CAVO	SPESSORE
0091864000	0,25÷1	0,4



CODICE	SEZIONE CAVO	SPESSORE
0091869000	0,25÷1	0,75



CODICE	SEZIONE CAVO	DIAM.	SPESSORE
0091864300	1÷2,5	4	0,4
0091864500	1÷2,5	5	0,4



CODICE	SEZIONE CAVO	SPESSORE
0091869100	1÷2,5	0,8



CODICE	SEZIONE CAVO	SPESSORE
0091864700	2,5÷6	0,4



CODICE	SEZIONE CAVO	SPESSORE
0091869200	2,5÷6	1

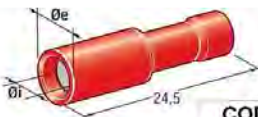

CODICE	SEZIONE CAVO	SPESSORE
0091864100	0,25÷1	0,4

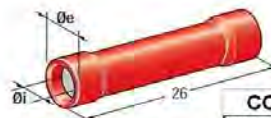

CODICE	SEZIONE CAVO	SPESSORE
0091868000	0,25÷1	0,4



CODICE	SEZIONE CAVO	DIAM.	SPESSORE
0091864400	1÷2,5	6,3	0,4
0091864600	1÷2,5	7	0,4

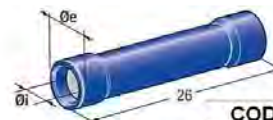

CODICE	SEZIONE CAVO	SPESSORE
0091868100	1÷2,5	0,4

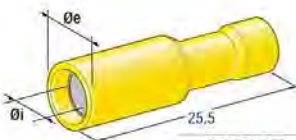

CODICE	SEZIONE CAVO	SPESSORE
0091864800	2,5÷6	0,4

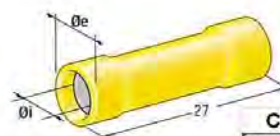

CODICE	SEZIONE CAVO	SPESSORE
0091868200	2,5÷6	0,4



CODICE	SEZIONE CAVO	SPESSORE
0091880300	0,75÷1,25	0,4

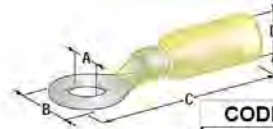

CODICE	SEZIONE CAVO	DIAM.	SPESSORE
0091880120	2,5÷6	5,3	1
0091880130	2,5÷6	6,4	1
0091880140	2,5÷6	8,4	1
0091880150	2,5÷6	10,5	1



CODICE	SEZIONE CAVO	SPESSORE
0091880310	1,25÷2,5	0,4



CODICE	SEZIONE CAVO	SPESSORE
0091880160	0,75÷1,25	0,8



CODICE	SEZIONE CAVO
0091880280	0,75÷1,25



CODICE	SEZIONE CAVO	DIAM.	SPESSORE
0091880180	1,25÷2,5	4,3	0,8
0091880190	1,25÷2,5	5,3	0,8



CODICE	SEZIONE CAVO
0091880290	1,25÷2,5



CODICE	SEZIONE CAVO	DIAM.	SPESSORE
0091880200	2,5÷6	4,3	1
0091880210	2,5÷6	5,3	1

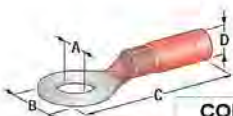

CODICE	SEZIONE CAVO	DIAM.	SPESSORE
0091880020	0,75÷1,25	5,3	0,8
0091880030	0,75÷1,25	6,4	0,8
0091880040	0,75÷1,25	8,4	0,8



CODICE	SEZIONE CAVO	SPESSORE
0091880230	0,25÷1	0,4

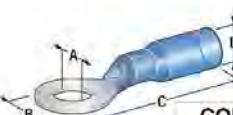

CODICE	SEZIONE CAVO	DIAM.	SPESSORE
0091880060	1,25÷2,5	4,3	0,8
0091880070	1,25÷2,5	5,3	0,8
0091880080	1,25÷2,5	6,4	0,8
0091880090	1,25÷2,5	8,4	0,8
0091880100	1,25÷2,5	10,5	0,8



CODICE	SEZIONE CAVO	SPESSORE
0091880240	1,÷2,5	0,4

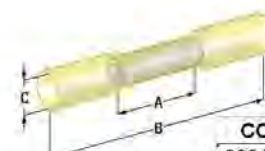

CODICE	SEZIONE CAVO	SPESSORE
0091880250	2,5÷6	0,4

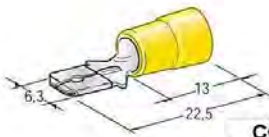

CODICE	SEZIONE CAVO	SPESSORE
0091862000	2,5÷6	0,8

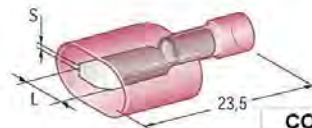

CODICE	SEZIONE CAVO	SPESSORE
0091852400	0,25÷1	0,8

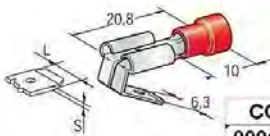

CODICE	SEZIONE CAVO	SPESSORE
0091852500	0,25÷1	0,4

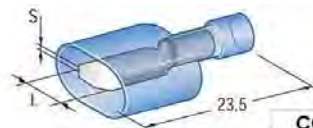

CODICE	SEZIONE CAVO	SPESSORE
0091856400	1÷2,5	0,8

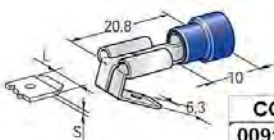

CODICE	SEZIONE CAVO	SPESSORE
0091862500	1÷2,5	0,4

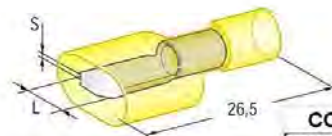

CODICE	SEZIONE CAVO	SPESSORE
0091862400	2,5÷6	0,8

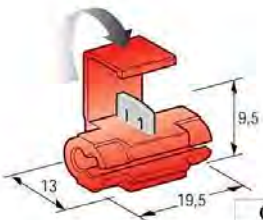

CODICE	SEZIONE CAVO
0094410090	0,25÷1

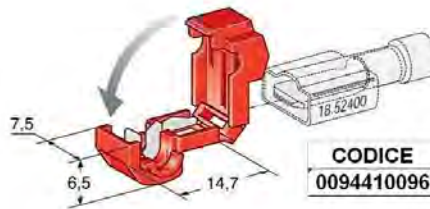

CODICE	SEZIONE CAVO
0094410096	0,25÷1

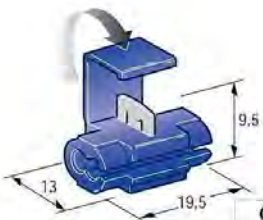

CODICE	SEZIONE CAVO
0094410091	1÷2,5

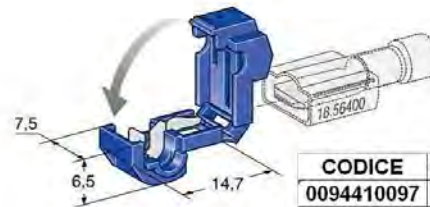

CODICE	SEZIONE CAVO
0094410097	1÷2,5

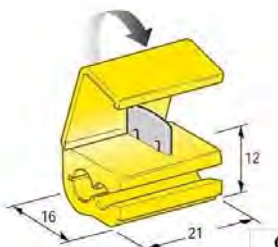

CODICE	SEZIONE CAVO
0094410092	2,5÷6

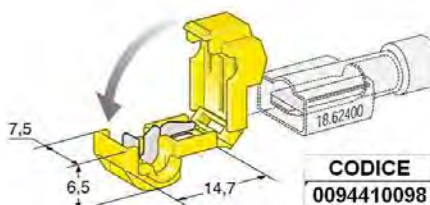

CODICE	SEZIONE CAVO
0094410098	2,5÷6

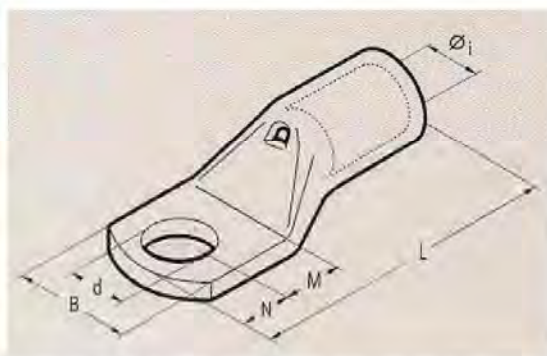
Capicorda per conduttori in rame

CODICE	sez. conduttore rigido - flex	Ø vite mm	dimensioni mm					
			Ø	B	M	N	L	d
004A03M3	0,25÷1,5	3	1,8	6,0	4,5	3,5	16,0	3,2
004A03M3,5	0,25÷1,5	3,5	1,8	6,5	4,5	3,5	16,0	3,7
004A03M4	0,25÷1,5	4	1,8	6,5	5,0	4,0	17,0	4,3
004A03M5	0,25÷1,5	5	1,8	7,5	5,5	4,5	18,0	5,3
004A03M6	0,25÷1,5	6	1,8	9,0	6,0	5,0	19,0	6,4
004A06M3	1,5÷2,5	3	2,4	6,0	4,5	3,5	17,0	3,2
004A06M3,5	1,5÷2,5	3,5	2,4	6,5	4,5	3,5	17,0	3,7
004A06M4	1,5÷2,5	4	2,4	7,5	5,0	4,0	18,0	4,3
004A06M5	1,5÷2,5	5	2,4	8,5	5,5	4,5	19,0	5,3
004A06M6	1,5÷2,5	6	2,4	9,0	6,0	5,0	20,0	6,4
004A06M8	1,5÷2,5	8	2,4	12,0	9,0	8,0	26,0	8,4
004A1M3	4÷6	3	3,6	7,5	4,5	3,5	20,5	3,2
004A1M3,5	4÷6	3,5	3,6	7,5	4,5	3,5	20,5	3,7
004A1M4	4÷6	4	3,6	8,0	5,0	4,0	21,5	4,3
004A1M5	4÷6	5	3,6	9,0	6,5	6,0	25,0	5,3
004A1M6	4÷6	6	3,6	11,0	7,0	6,0	25,5	6,4
004A1M8	4÷6	8	3,6	14,0	9,0	8,0	29,5	8,4
004A1M10	4÷6	10	3,6	16,0	11,0	10,0	33,5	10,5
004A2M4	10	4	4,6	10,0	5,0	4,0	22,5	4,3
004A2M5	10	5	4,6	10,0	6,5	6,0	26,0	5,3
004A2M6	10	6	4,6	11,0	7,0	6,0	26,5	6,4
004A2M8	10	8	4,6	15,0	9,0	8,0	30,5	8,4
004A2M10	10	10	4,6	18,0	11,0	10,0	34,5	10,5
004A2M12	10	12	4,6	19,0	14,0	12,0	39,5	13,2
004A3M4	16	4	5,8	11,5	5,0	4,0	25,5	4,3
004A3M5	16	5	5,8	11,5	6,5	6,0	29,0	5,3
004A3M6	16	6	5,8	11,5	7,0	6,0	29,5	6,4
004A3M8	16	8	5,8	15,0	9,0	8,0	33,5	8,4
004A3M10	16	10	5,8	18,0	11,0	10,0	37,5	10,5
004A3M12	16	12	5,8	20,0	14,0	12,0	42,5	13,2
004A5M4	25	4	7,0	14,0	5,0	4,0	28,0	4,3
004A5M5	25	5	7,0	14,0	6,5	6,0	31,5	5,3
004A5M6	25	6	7,0	14,0	7,0	6,0	32,0	6,4
004A5M8	25	8	7,0	15,0	9,0	8,0	36,0	8,4
004A5M10	25	10	7,0	18,0	11,0	10,0	40,0	10,5
004A5M12	25	12	7,0	21,0	14,0	12,0	45,0	13,2
004A7M5	35 - 25/35	5	8,9	17,0	6,5	6,0	34,0	5,3
004A7M6	35 - 25/35	6	8,9	17,0	7,0	6,0	34,5	6,4
004A7M8	35 - 25/35	8	8,9	17,0	9,0	8,0	38,5	8,4
004A7M10	35 - 25/35	10	8,9	19,0	11,0	10,0	42,5	10,5
004A7M12	35 - 25/35	12	8,9	21,0	14,0	12,0	47,5	13,2
004A10M6	50 - 35/50	6	10,0	19,0	8,0	7,0	40,5	6,4
004A10M8	50 - 35/50	8	10,0	19,0	9,0	8,0	42,5	8,4
004A10M10	50 - 35/50	10	10,0	20,0	11,0	10,0	46,5	10,5
004A10M12	50 - 35/50	12	10,0	21,0	14,0	12,0	51,5	13,2
004A10M14	50 - 35/50	14	10,0	25,0	16,0	14,0	55,5	15,0
004A10M16	51 - 35/50	16	10,0	26,0	18,0	16,0	59,5	17,0
004A14M6	70 - 50/70	6	11,3	21,0	8,0	7,0	44,0	6,4
004A14M8	70 - 50/70	8	11,3	21,0	9,0	8,0	46,0	8,4
004A14M10	70 - 50/70	10	11,3	21,0	11,0	10,0	50,0	10,5
004A14M12	70 - 50/70	12	11,3	22,0	14,0	12,0	55,0	13,2
004A14M14	70 - 50/70	14	11,3	25,0	16,0	14,0	59,0	15,0

Capicorda preisolati in PA 6.6 per cavi in rame flessibilissimi, classi 5 e 6

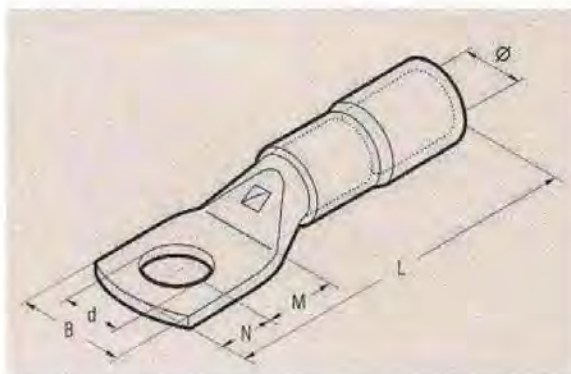

CODICE	sez. cavo	Ø vite mm	dimensioni mm					
			Ø	B	M	N	L	d
004ANE9M615	35	6	13,6	15,0	8,0	7,0	54,0	6,4
004ANE9M8	35	8	13,6	17,0	9,0	8,0	56,0	8,4
004ANE9M10	35	10	13,6	18,5	11,0	10,0	60,0	10,5
004ANE9M12	35	12	13,6	21,0	14,0	12,0	65,0	13,2
004ANE12M615	50	6	15,7	15,0	8,0	7,0	59,5	6,4
004ANE12M8	50	8	15,7	19,8	9,0	8,0	61,5	8,4
004ANE12M610	50	10	15,7	19,8	11,0	10,0	65,5	10,5
004ANE12M1019	50	10	15,7	19,0	11,0	10,0	65,5	10,5
004ANE12M12	50	12	15,7	22,0	14,0	12,0	70,5	13,2
004ANE17M6	70	6	17,9	23,0	8,0	7,0	63,8	6,4
004ANE17M8	70	8	17,9	23,0	9,0	8,0	65,8	8,4
004ANE17M10	70	10	17,9	23,0	11,0	10,0	69,8	10,5
004ANE17M1019	70	10	17,9	19,0	11,0	10,0	69,8	10,5
004ANE17M12	70	12	17,9	23,0	14,0	12,0	74,8	13,2
004ANE17M14	70	14	17,9	25,0	15,5	12,0	76,3	15,0
004ANE17M16	70	16	17,9	27,0	16,5	13,5	78,8	17,0
004ANE20M8	95	8	20,0	27,0	9,0	8,0	70,6	8,4
004ANE20M10	95	10	20,0	27,0	11,0	10,0	74,6	10,5
004ANE20M12	95	12	20,0	27,0	14,0	12,0	79,6	13,2
004ANE20M14	95	14	20,0	27,0	15,5	12,0	81,1	15,0
004ANE20M16	95	16	20,0	27,0	16,5	13,5	83,6	17,0
004ANE29M10	120	10	22,4	30,0	11,0	10,0	81,5	10,5
004ANE29M12	120	12	22,4	30,0	14,0	12,0	86,5	13,2
004ANE29M14	120	14	22,4	30,0	15,5	12,0	88,5	15,0
004ANE29M16	120	16	22,4	30,0	16,5	13,5	90,5	17,0
004ANE29M20	120	20	22,4	30,0	22,0	20,0	102,5	21,0
004ANE35M12	150	12	25,0	34,2	16,0	14,0	95,0	13,2
004ANE35M14	150	14	25,0	34,2	18,0	16,0	99,0	15,0
004ANE35M16	150	16	25,0	34,2	19,0	17,0	101,0	17,0
004ANE35M20	150	20	25,0	34,2	22,0	20,0	107,0	21,0

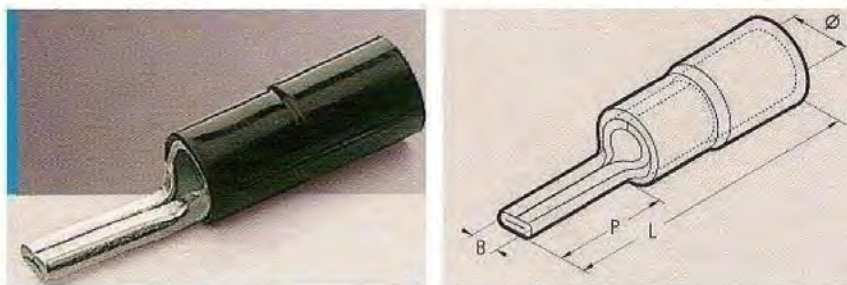
Capicorda preisolati in PA 6.6 con attacco a puntale per cavi in rame

CODICE	sez. cavo	dimensioni mm			
		Ø	B	P	L
004ANE2P12	10	8,0	4,3	14,5	35,1
004ANE3P14	16	9,0	5,5	18,0	41,1
004ANE5P16	25	11,1	7,0	20,3	45,0
004ANE7P20	35	13,6	8,0	24,5	55,0

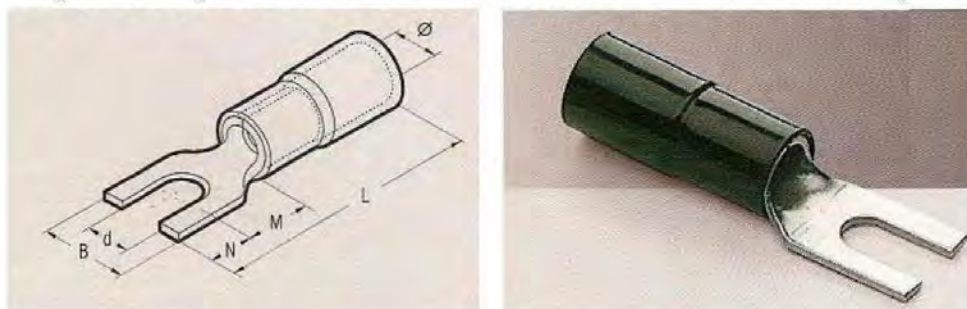
Capicorda preisolati in PA 6.6 con attacco a forcella per cavi in rame

CODICE	sez. cavo	Ø vite mm	dimensioni mm					
			Ø	B	M	N	L	d
004ANE2U4	10	4	8,0	9,8	7,5	7,0	35,1	4,3
004ANE2U5	10	5	8,0	11,5	7,5	7,0	35,1	5,3
004ANE3U4	16	4	9,2	10,0	10,0	8,0	41,1	4,3
004ANE3U5	16	5	9,2	11,5	10,0	8,0	41,1	5,3

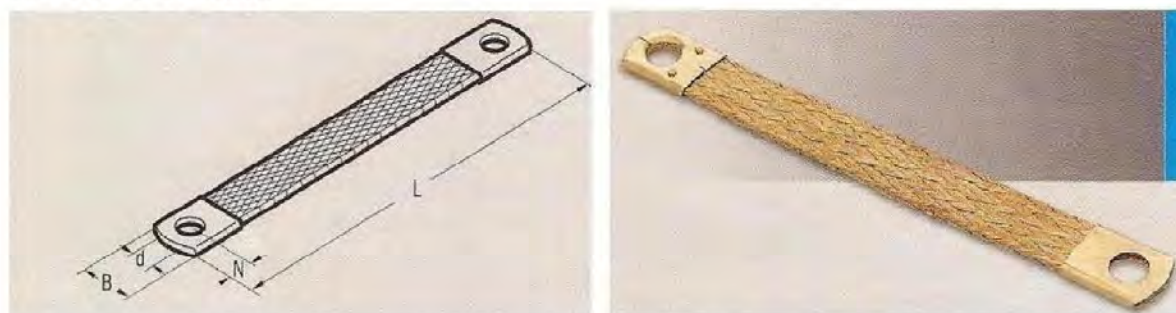
Trecce flessibili

CODICE	sez. cavo	Ø vite mm	dimensioni mm		
			B	N	L
00910150	10	8	17	10	150
00910200	10	8	17	10	200
00910250	10	8	17	10	250
00916150	16	8	17	10	150
00916200	16	8	17	10	200
00916250	16	8	17	10	250
00916320	16	8	17	10	320
00916350	16	8	17	10	350
00916420	16	8	17	10	420
00916570	16	8	17	10	570
00916660	16	8	17	10	660
00925150	25	8	21	10	150
00925200	25	8	21	10	200
00925250	25	8	21	10	250
00925300	25	8	21	10	300

004Z02501

004Z0601

004Z1001

004Z1601

004Z2501

004Z3501

Morsetti ad UNA VIA a serraggio indiretto

CODICE	sezione nominale mmq	tensione nominale V	temperatura Max di funzionamento	grado di protezione	autoestinguenza	dimesioni mm	peso g
004Z02501	2,5	450	85	IP 20	V-O (UL 94)	7,6x20xh23,5	3
004Z0601	6	450	85	IP 20	V-O (UL 94)	11,5x28xh29	6
004Z1001	10	450	85	IP 20	V-O (UL 94)	15,6x32xh32,5	11
004Z1601	16	450	85	IP 20	V-O (UL 94)	18x34xh38	15
004Z2501	25	450	85	IP 20	V-O (UL 94)	20,8x42,5xh43,5	29
004Z3501	35	450	85	IP 20	V-O (UL 94)	25x45xh51,5	37

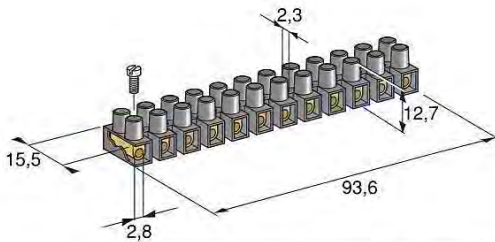

CODICE	N. VIE	VOLT	In	DESCRIZIONE	TEMPERATURA ESERCIZIO	SEZ. CAVO
0094430100	12	380	24A	connettore STRIPS nero	85° C	2,5

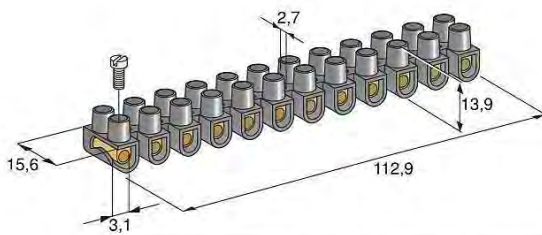

CODICE	N. VIE	VOLT	In	DESCRIZIONE	TEMPERATURA ESERCIZIO	SEZ. CAVO
0094430110	12	380	24A	connettore STRIPS nero	85° C	6

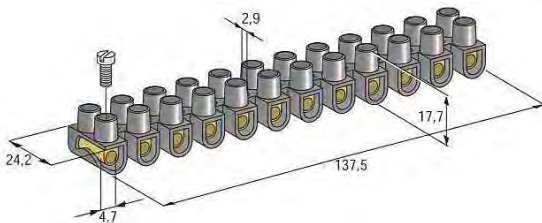

CODICE	N. VIE	VOLT	In	DESCRIZIONE	TEMPERATURA ESERCIZIO	SEZ. CAVO
0094430120	12	450	24A	connettore STRIPS nero	85° C	10

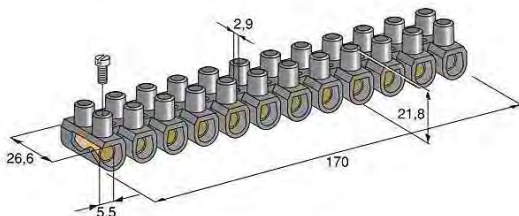

CODICE	N. VIE	VOLT	In	DESCRIZIONE	TEMPERATURA ESERCIZIO	SEZ. CAVO
0094430130	12	450	24A	connettore STRIPS nero	85° C	16

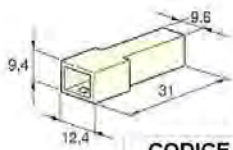

CODICE	N. VIE	DESCRIZIONE
0094410150	1	connettore portamaschi neutro

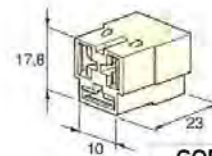
GND L32

CODICE	N. VIE	DESCRIZIONE
0094410220	3	connettore portafemmine neutro

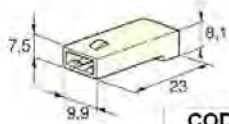

CODICE	N. VIE	DESCRIZIONE
0094410160	1	connettore portafemmine neutro

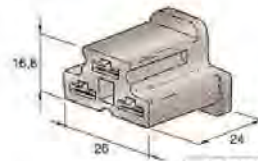
GND F L32

CODICE	N. VIE	DESCRIZIONE
0094410140	3	connettore portafemmine nero

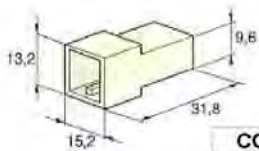

CODICE	N. VIE	DESCRIZIONE
0094410170	2	connettore portamaschi neutro

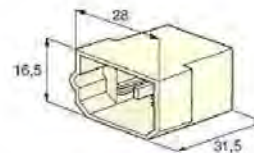

CODICE	N. VIE	DESCRIZIONE
0094410230	4	connettore portamaschi neutro

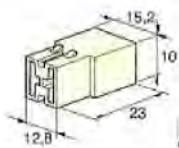

CODICE	N. VIE	DESCRIZIONE
0094410180	2	connettore portafemmine neutro

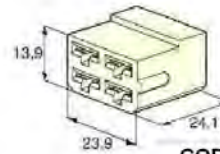

CODICE	N. VIE	DESCRIZIONE
0094410240	4	connettore portafemmine nero

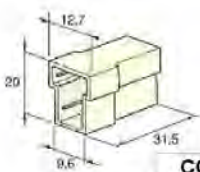

CODICE	N. VIE	DESCRIZIONE
0094410190	2	connettore portamaschi neutro

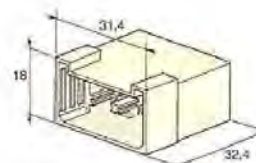

CODICE	N. VIE	DESCRIZIONE
0094410250	6	connettore portamaschi neutro

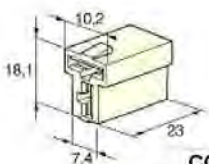

CODICE	N. VIE	DESCRIZIONE
0094410200	2	connettore portafemmine neutro

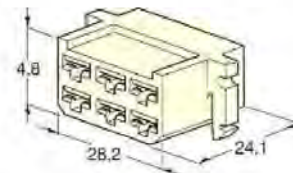

CODICE	N. VIE	DESCRIZIONE
0094410260	6	connettore portafemmine nero

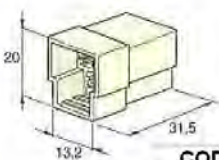

CODICE	N. VIE	DESCRIZIONE
0094410210	3	connettore portamaschi neutro

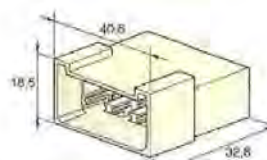

CODICE	N. VIE	DESCRIZIONE
0094410270	8	connettore portamaschi neutro

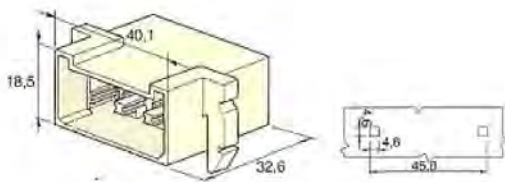

CODICE	N. VIE	DESCRIZIONE
0094410290	8	connettore portamaschi neutro

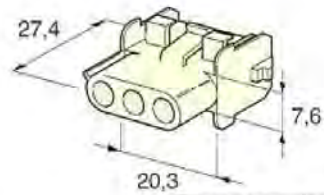

CODICE	N. VIE	DESCRIZIONE
0094426060	3	connettore portamaschi/femmine neutro

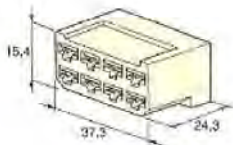

CODICE	N. VIE	DESCRIZIONE
0094410280	8	connettore portafemmine neutro

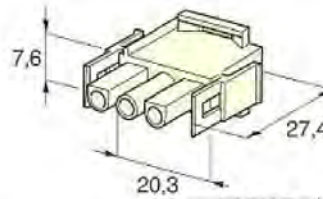

CODICE	N. VIE	DESCRIZIONE
0094426050	3	connettore portamaschi/femmine neutro

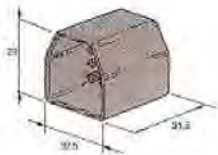

CODICE	N. VIE	DESCRIZIONE
0094410295	11	connettore portamaschi nero

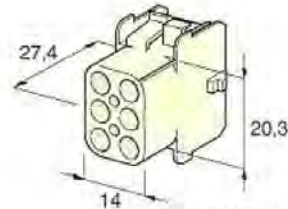

CODICE	N. VIE	DESCRIZIONE
0094426120	6	connettore portamaschi/femmine neutro



CODICE	N. VIE	DESCRIZIONE
0094410296	11	connettore portafemmine nero

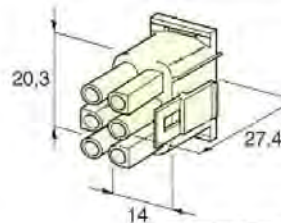

CODICE	N. VIE	DESCRIZIONE
0094426110	6	connettore portamaschi/femmine neutro

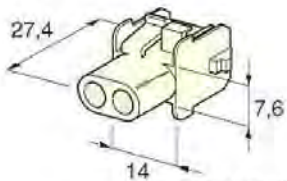

CODICE	N. VIE	DESCRIZIONE
0094426040	2	connettore portamaschi/femmine neutro

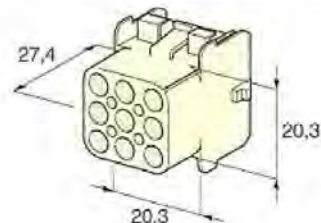

CODICE	N. VIE	DESCRIZIONE
0094426140	9	connettore portamaschi/femmine neutro

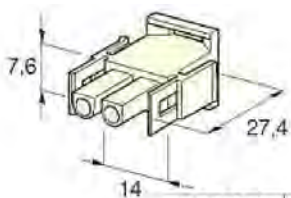

CODICE	N. VIE	DESCRIZIONE
0094426030	2	connettore portamaschi/femmine neutro

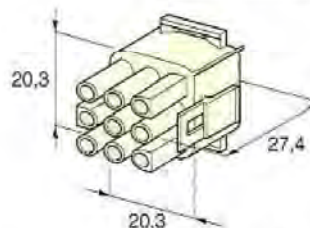

CODICE	N. VIE	DESCRIZIONE
0094426130	9	connettore portamaschi/femmine neutro

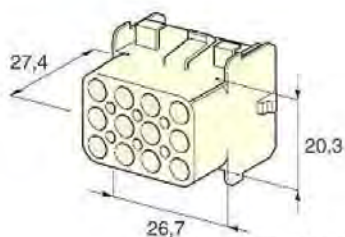

CODICE	N. VIE	DESCRIZIONE
0094426160	12	connettore portamaschi/femmine neutro

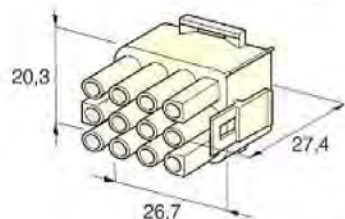

CODICE	N. VIE	DESCRIZIONE
0094426150	12	connettore portamaschi/femmine neutro

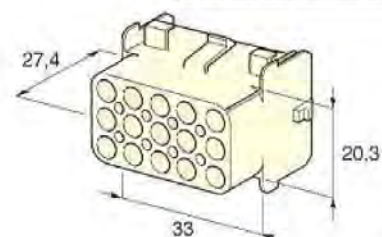

CODICE	N. VIE	DESCRIZIONE
0094426180	15	connettore portamaschi/femmine neutro

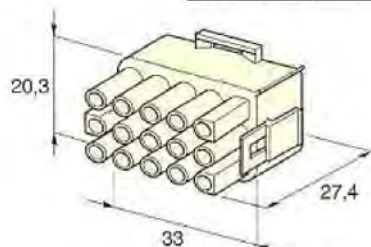

CODICE	N. VIE	DESCRIZIONE
0094426170	15	connettore portamaschi/femmine neutro

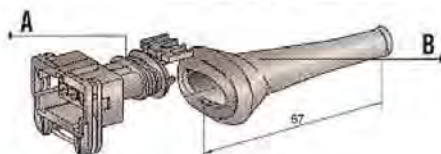

Con molletta di ritegno,

CODICE	N. VIE	DESCRIZIONE
0094420920	3	A) connettore nero
0094420921	3	B) cappuccio in gomma nero

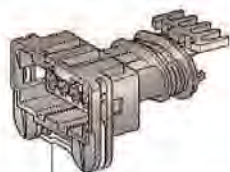

Con molletta di ritegno,

CODICE	N. VIE	DESCRIZIONE
0094410655	4	connettore nero

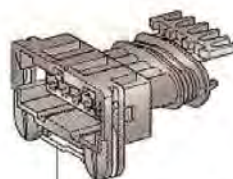

Con molletta di ritegno,

CODICE	N. VIE	DESCRIZIONE
0094410656	5	connettore nero

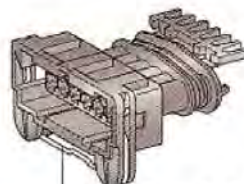

Con molletta di ritegno,

CODICE	N. VIE	DESCRIZIONE
0094420657	6	connettore nero

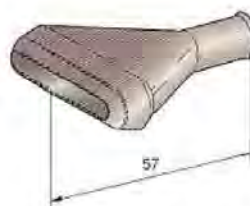

CODICE	N. VIE	DESCRIZIONE
0094420931	7	cappuccio in gomma nero



CODICE	N. VIE	DESCRIZIONE
0094410660	2	connettore nero

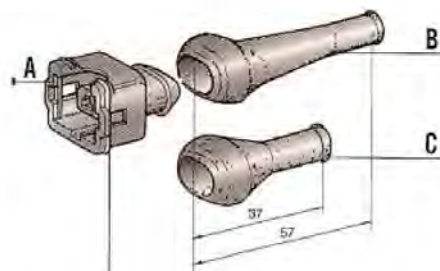

Con molletta di ritegno,

CODICE	N. VIE	DESCRIZIONE
0094420900	2	A) connettore nero
0094420901	2	B) cappuccio in gomma nero
0094420902	2	C) cappuccio in gomma nero



CODICE	N. VIE	DESCRIZIONE
0094410661	2	connettore nero

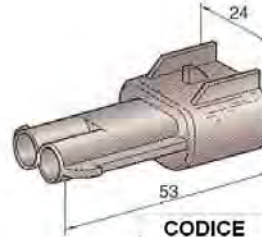

CODICE	N. VIE	DESCRIZIONE
0094423540	2	connettore portamaschi nero

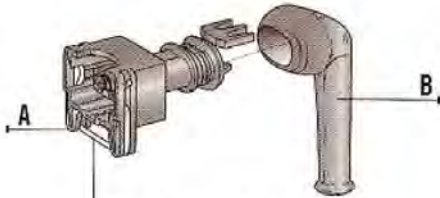

Con molletta di ritegno.

CODICE	N. VIE	DESCRIZIONE
0094420910	2	A) connettore nero
0094420911	2	B) cappuccio in gomma nero

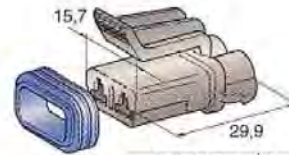

CODICE	N. VIE	DESCRIZIONE
0094423530	2	connettore portafemmine nero

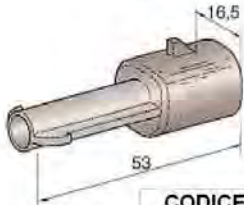

CODICE	N. VIE	DESCRIZIONE
0094423520	1	connettore portamaschi nero

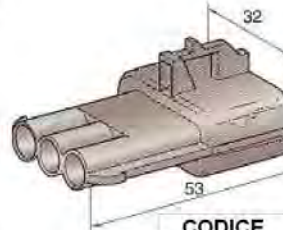

CODICE	N. VIE	DESCRIZIONE
0094423560	3	connettore portamaschi nero



CODICE	N. VIE	DESCRIZIONE
0094423510	1	connettore portafemmine nero

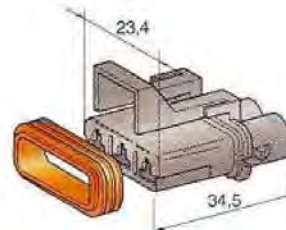

CODICE	N. VIE	DESCRIZIONE
0094423550	3	connettore portafemmine nero

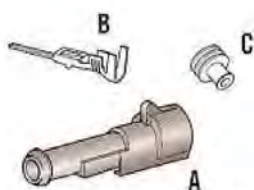

CODICE	N. VIE	DESCRIZIONE
0094423610	1	connettore portamaschi nero

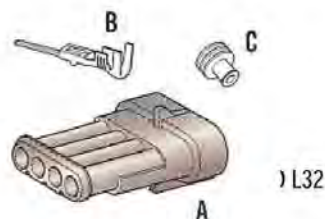

CODICE	N. VIE	DESCRIZIONE
0094423670	4	connettore portamaschi nero

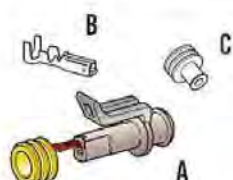

CODICE	N. VIE	DESCRIZIONE
0094423620	1	connettore portafemmine nero

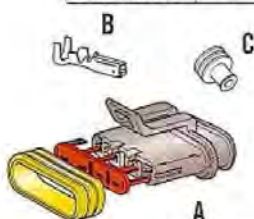

CODICE	N. VIE	DESCRIZIONE
0094423680	4	connettore portafemmine nero

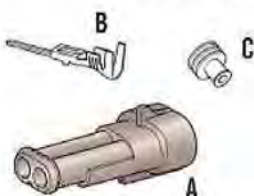

CODICE	N. VIE	DESCRIZIONE
0094423630	2	connettore portamaschi nero

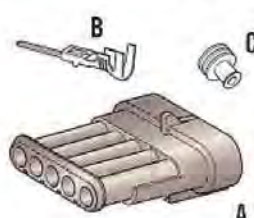

CODICE	N. VIE	DESCRIZIONE
0094423690	5	connettore portamaschi nero

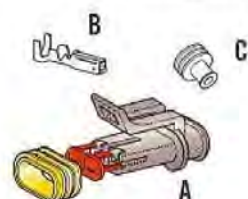

CODICE	N. VIE	DESCRIZIONE
0094423640	2	connettore portafemmine nero

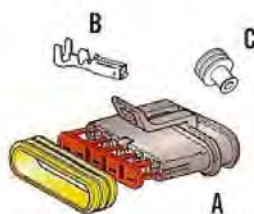

CODICE	N. VIE	DESCRIZIONE
0094423700	5	connettore portafemmine nero

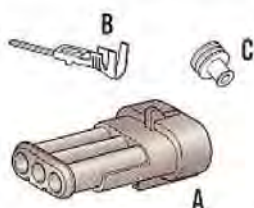

CODICE	N. VIE	DESCRIZIONE
0094423650	3	connettore portamaschi nero

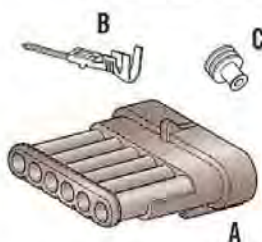

CODICE	N. VIE	DESCRIZIONE
0094423710	6	connettore portamaschi nero

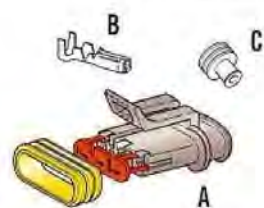

CODICE	N. VIE	DESCRIZIONE
0094423660	3	connettore portafemmine nero

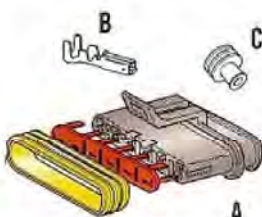

CODICE	N. VIE	DESCRIZIONE
0094423720	6	connettore portafemmine nero

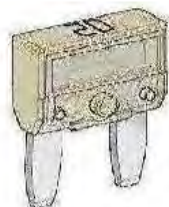

CODICE	N. VIE	DESCRIZIONE
0094423355	3	tappo diagnostica

MINIVAL

AMP	COLORE	CODICE
2A		00550431020
3A		00550431030
4A		00550431040
5A		00550431050
7,5A		00550431075
10A		00550431100
15A		00550431150
20A		00550431200
25A		00550431250
30A		00550431300

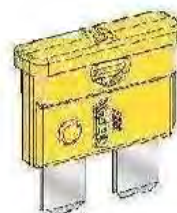



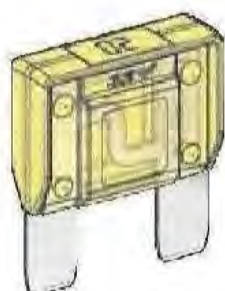





UNIVAL

AMP	COLORE	CODICE
1A		00550432010
2A		00550432020
3A		00550432030
4A		00550432040
5A		00550432050
7.5A		00550432075
10A		00550432100
15A		00550432150
20A		00550432200
25A		00550432250
30A		00550432300
40A		00550432400

MAXIVAL







AMP	COLORE	CODICE
20A		00550433200
30A		00550433300
40A		00550433400
50A		00550433500
60A		00550433600
70A		00550433700
80A		00550433800
100A		00550433900

MICROVAL

AMP	COLORE	CODICE
2A		0090600210
3A		0090600220
4A		0090600230
5A		0090600240
7.5A		0090600250
10A		0090600260
15A		0090600270
20A		0090600280
25A		0090600290
30A		0090600302





JAPVAL MINI FEMALE 14

20A		0090474020
30A		0090474030
40A		0090474040
50A		0090474050
60A		0090474060
70A		0090474070
80A		0090474080





JAPVAL MINI CLIP

25A		0090476025
30A		0090476030



JAPVAL MINI FEMALE 18

30A		0090473030
40A		0090473040



JAPVAL CLIP

45A		0090477065
65A		0090477065
75A		0090477075

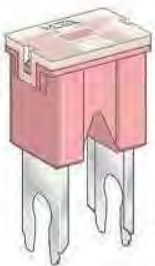



JAPVAL MALE

30A		0090471030
40A		0090471040
50A		0090471050
60A		0090471060
80A		0090471080
100A		0090471100



JAPVAL FEMALE

20A		0090470020
30A		0090470030
40A		0090470040
50A		0090470050
60A		0090470060
80A		0090470080
100A		0090470100













JAPVAL MALE 48 MALE 62







20A		0090475020
30A		0090475030
40A		0090475040
50A		0090475050
60A		0090475060
70A		0090475070
80A		0090475080
100A		0090475100
30A		0090472030
40A		0090472040
50A		0090472050
60A		0090472060
80A		0090472080
100A		0090472100

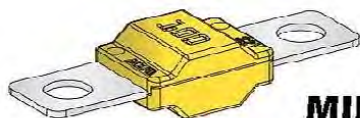

CONTINENTAL

5A		0090200140
5A		0090200142
8A		0090200150
8A		0090200151
8A		0090200149
10A		0090200152
16A		0090200170
16A		0090200171
16A		0090200172
25A		0090200180
25A		0090200181
25A		0090200182

MIDIVAL

AMP	COLORE	CODICE
30A		0090602125
40A		0090602040
50A		0090602050
60A		0090602060
70A		0090602070
80A		0090602080
100A		0090602100
125A		0090602030

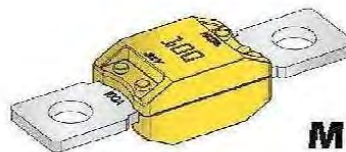
MEGAVAL

AMP	COLORE	CODICE
100A		0090601100
125A		0090601125
150A		0090601150
175A		0090601175
200A		0090601200
225A		0090601225
250A		0090601250
500A		0090601600

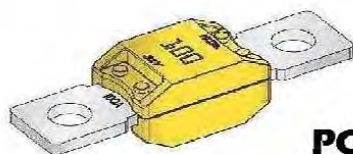
POWERVAL

AMP	COLORE	CODICE
CAL.1		0090601350
CAL.2		0090601400
CAL.3		0090601450
CAL.4		0090601500
CAL.5		0090601700

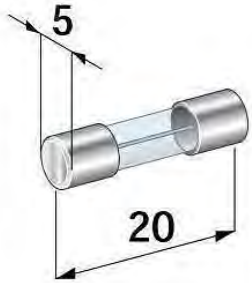
Rapid Type 12 V - 24 V

GLASS

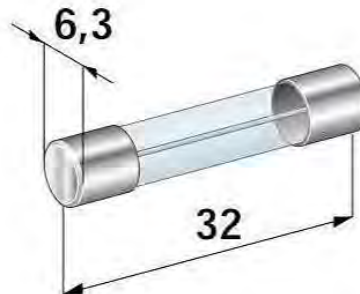
250mA	0090430200
500mA	0090430300
1A	0090430400
2A	0090430500
3A	0090430600
4A	0090430700
5A	0090430800
6A	0090430900
8A	0090431000
10A	0090431100
12A	0090431200
15A	0090431300
20A	0090431400

GLASS

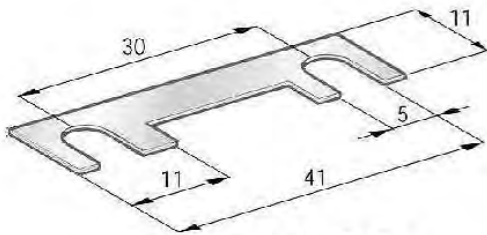
1A	0090433100
2A	0090433200
3A	0090433300
5A	0090433400
7,5A	0090433450
10A	0090433500
15A	0090433600
20A	0090433700
25A	0090433800
30A	0090433801
35A	0090433802

STRIP

30A	0090200296
40A	0090200300
50A	0090200297
60A	0090200301
80A	0090200298
100A	0090200299

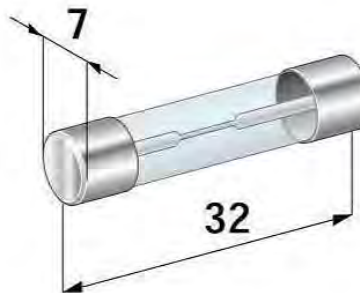
GLASS

5A	0090435100
8A	0090435200
10A	0090435300
15A	0090435400
25A	0090435500
30A	0090435600
35A	0090435700

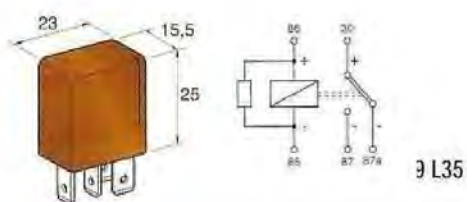
9 L35

CODICE	DESCRIZIONE	TENSIONE NOMINALE	CORRENTE NOMINALE A 80° C	TEMP. ESERCIZIO
0090603000	Relay micro MARRONE	10A NC 20A NA	12V	-40°C +125°C

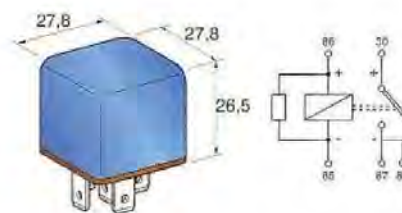

CODICE	DESCRIZIONE	TENSIONE NOMINALE	CORRENTE NOMINALE A 80° C	TEMP. ESERCIZIO
0090603040	Relay mini BLU	30A NA	12V	-40°C +125°C

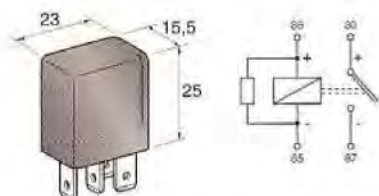

CODICE	DESCRIZIONE	TENSIONE NOMINALE	CORRENTE NOMINALE A 80° C	TEMP. ESERCIZIO
0090603010	Relay micro NERO	20A NA	12V	-40°C +125°C

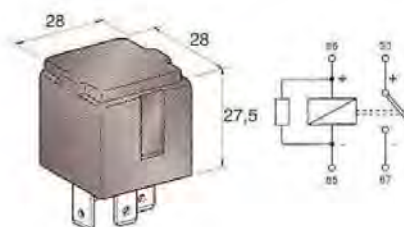

CODICE	DESCRIZIONE	TENSIONE NOMINALE	CORRENTE NOMINALE A 80° C	TEMP. ESERCIZIO
0090603050	Relay maxi NERO	50A NA	12V	-40°C +125°C

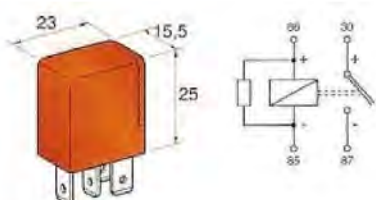

CODICE	DESCRIZIONE	TENSIONE NOMINALE	CORRENTE NOMINALE A 80° C	TEMP. ESERCIZIO
0090603020	Relay micro ROSSO	30A NA	12V	-40°C +125°C

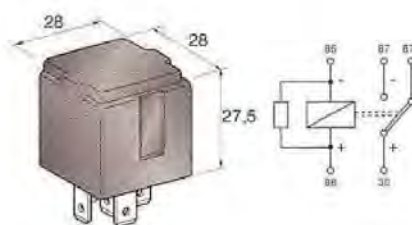

CODICE	DESCRIZIONE	TENSIONE NOMINALE	CORRENTE NOMINALE A 80° C	TEMP. ESERCIZIO
0090603060	Relay mini NERO	15A NC 30A NA	12V	-40°C +125°C

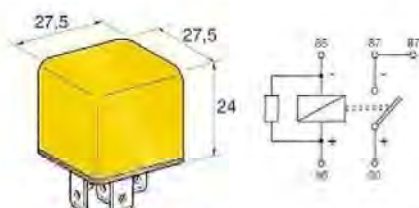

CODICE	DESCRIZIONE	TENSIONE NOMINALE	CORRENTE NOMINALE A 80° C	TEMP. ESERCIZIO
0090603030	Relay mini GIALLO	30A NA	12V	-40°C +125°C

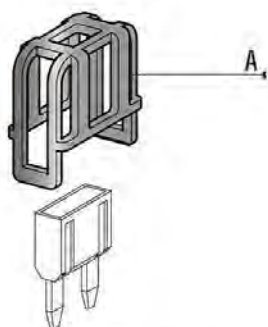
MINI

CODICE	DESCRIZIONE
0090100416	Gabbia di contenimento

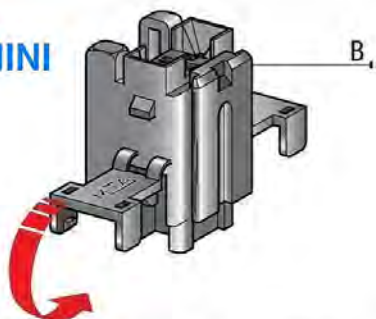
MINI

CODICE	DESCRIZIONE
0090101400	Portafusibile a chiusura laterale

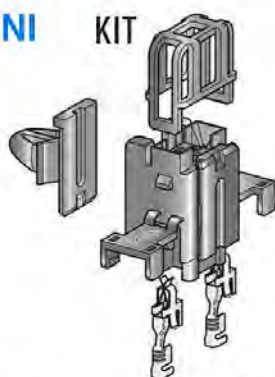
MINI

CODICE	DESCRIZIONE
0093050152	Kit A+B+Terminali+Piastrina

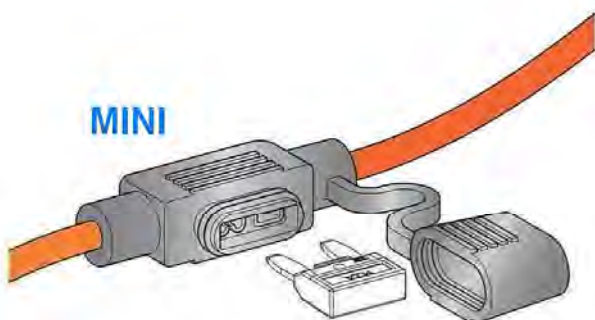
MINI

CODICE	DESCRIZIONE
0090100335	Portafusibile a tenuta stagna c/cavo 4 mm L=12 mm

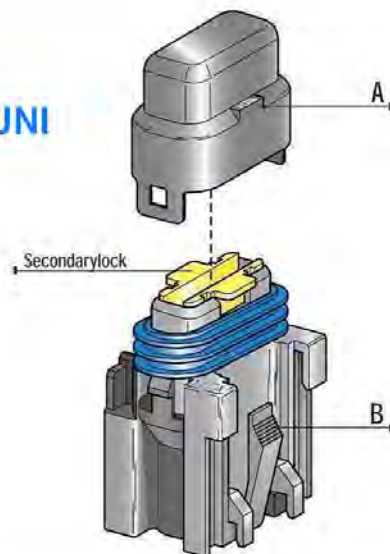
UNI

CODICE	DESCRIZIONE	AMP.
0090302305	Portafusibile splash-proof con guarnizione in silicone e coperchio	5A
0090301307	Portafusibile splash-proof con guarnizione in silicone e coperchio	7,5A
0090302310	Portafusibile splash-proof con guarnizione in silicone e coperchio	10A
0090302315	Portafusibile splash-proof con guarnizione in silicone e coperchio	15A
0090301320	Portafusibile splash-proof con guarnizione in silicone e coperchio	20A
0090302325	Portafusibile splash-proof con guarnizione in silicone e coperchio	25A
0090302330	Portafusibile splash-proof con guarnizione in silicone e coperchio	30A

UNI KIT

CODICE	DESCRIZIONE
0093050153	Kit A+B+Terminali+Piastrina

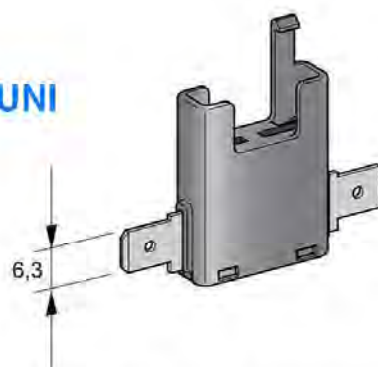
UNI

CODICE	DESCRIZIONE
0090100345	Portafusibile NKA

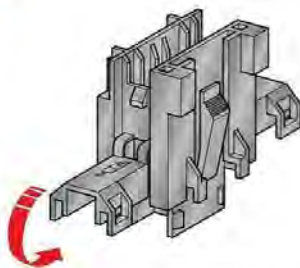
UNI

CODICE	DESCRIZIONE	AMP
0090100400	Portafusibile a chiusura laterale	2A
0090100401	Portafusibile a chiusura laterale	5A
0090100402	Portafusibile a chiusura laterale	7,5A
0090100403	Portafusibile a chiusura laterale	10A
0090100404	Portafusibile a chiusura laterale	15A
0090100405	Portafusibile a chiusura laterale	20A
0090100406	Portafusibile a chiusura laterale	25A
0090100407	Portafusibile a chiusura laterale	30A

UNI

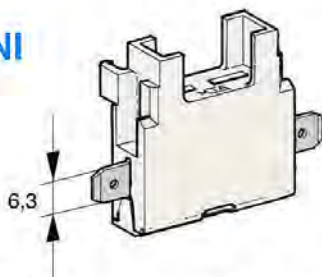

CODICE	DESCRIZIONE
0090100415	Gabbia di contenimento

UNI

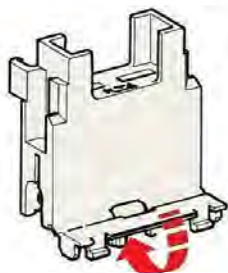
CODICE	DESCRIZIONE
0090100341	Portafusibile "IN LINE" con due terminali 19.07550

UNI

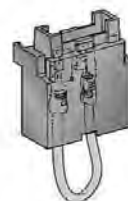
CODICE	DESCRIZIONE
0090100342	Portafusibile "IN LINE" senza terminali

UNI

CODICE	DESCRIZIONE
0090100350	Portafusibile con cavetti aggraffati

UNI

CODICE	DESCRIZIONE
0090100351	Portafusibile con 2 terminali 11.07501

UNI



CODICE	DESCRIZIONE
0090100354	Portafusibile senza terminale

UNI

CODICE	DESCRIZIONE
0090100359	Coperchio per protezione fusibile

UNI

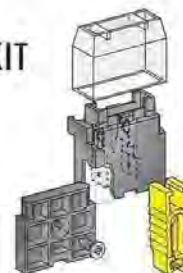

CODICE	DESCRIZIONE
0090100357	Optional Secondarylock

UNI
KIT

CODICE	DESCRIZIONE
0090100353	Kit A+B+Terminali+Piastrina+Coperchio

UNI

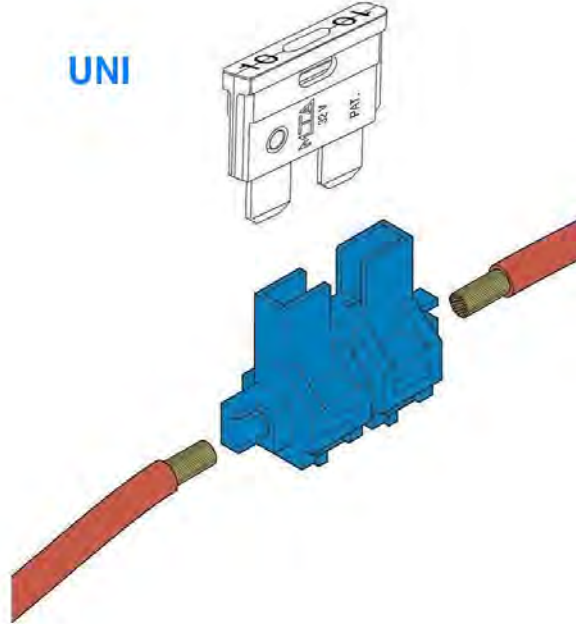
CODICE	DESCRIZIONE
0090100330	Portafusibile ad incasso con terminali

UNI

CODICE	DESCRIZIONE
0090100334	Portafusibile a chiusura rapida

UNI



CODICE	DESCRIZIONE
0090100331	Portafusibile senza terminali

UNI

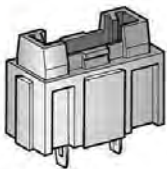
CODICE	DESCRIZIONE
0090100357	Optional Secondarylock

UNI

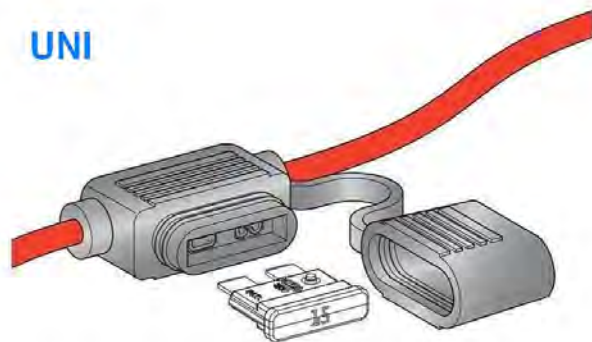
CODICE	DESCRIZIONE
0090100420	Portafusibile per circuiti stampati

UNI

CODICE	DESCRIZIONE
0090100336	Coperchio a tenta stagna c/cavo 4 mm L=12 mm

UNI

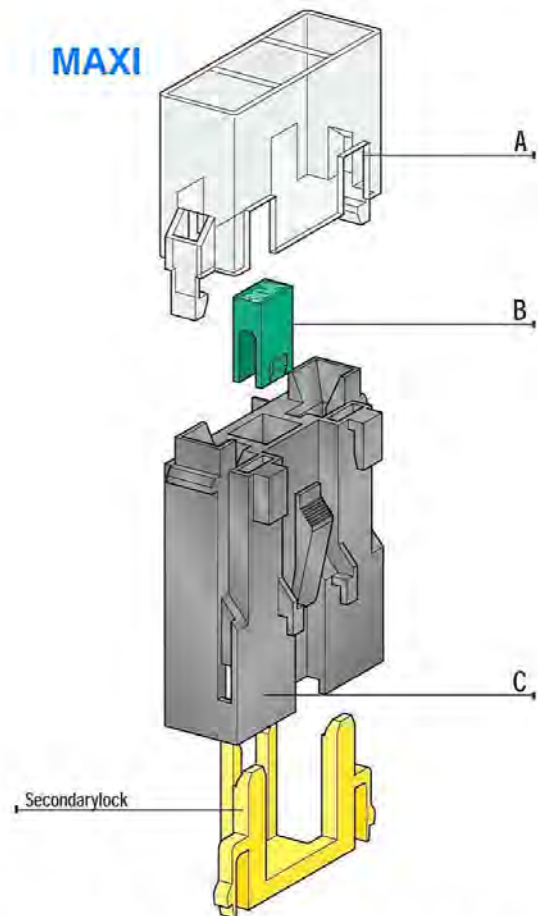
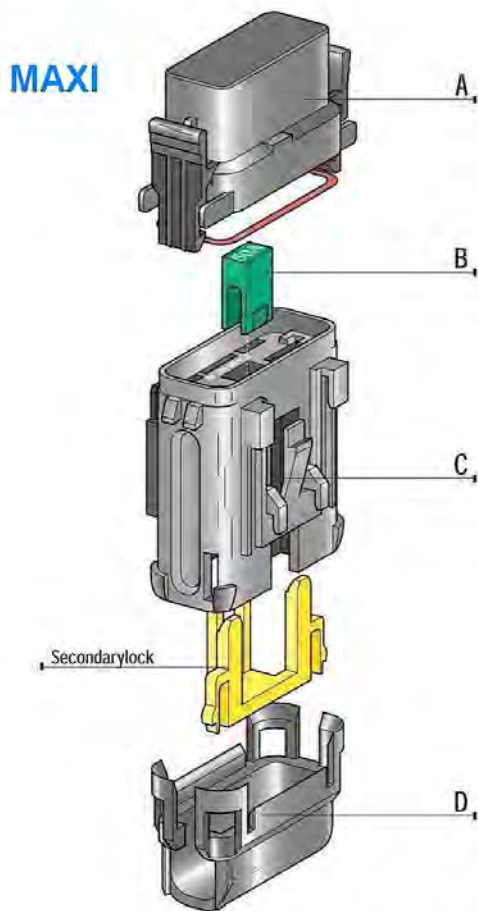

CODICE	DESCRIZIONE
0090100359	Coperchio per protezione fusibile



	CODICE	DESCRIZIONE	AMP
A=	0090321210	Coperchio per guarnizione	-
B=	0090301030	Optional: Tassello identificazione amperaggio PBT GF20	30A
B=	0090301040	Optional: Tassello identificazione amperaggio PBT GF20	40A
B=	0090301050	Optional: Tassello identificazione amperaggio PBT GF20	50A
B=	0090301060	Optional: Tassello identificazione amperaggio PBT GF20	60A
B=	0090301070	Optional: Tassello identificazione amperaggio PBT GF20	70A
B=	0090301080	Optional: Tassello identificazione amperaggio PBT GF20	80A
C=	0090321000	Portafusibile splash-proof con secondarylock	-
D=	0090321200	Coperchio inferiore	-

	CODICE	DESCRIZIONE	AMP
A=	0090100391	Coperchio per guarnizione	-
B=	0090301030	Optional: Tassello identificazione amperaggio PBT GF20	30A
B=	0090301040	Optional: Tassello identificazione amperaggio PBT GF20	40A
B=	0090301050	Optional: Tassello identificazione amperaggio PBT GF20	50A
B=	0090301060	Optional: Tassello identificazione amperaggio PBT GF20	60A
B=	0090301070	Optional: Tassello identificazione amperaggio PBT GF20	70A
B=	0090301080	Optional: Tassello identificazione amperaggio PBT GF20	80A
C=	0090100390	Portafusibile splash-proof con secondarylock	-

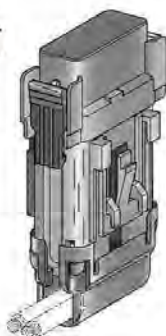
MAXI KIT



CODICE	DESCRIZIONE
0090101005	Kit A+B+C+D+Terminali 11.07660

MAXI KIT

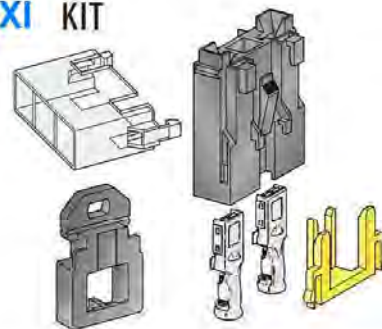

CODICE	DESCRIZIONE
0093001001	Kit A+C+Terminali+Piastrina

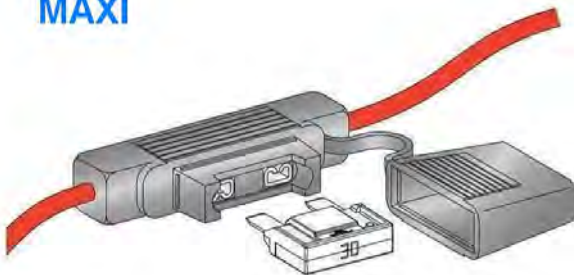
MAXI

CODICE	DESCRIZIONE
0090100337	Portafusibile a tenuta stagna c/cavo 10 mm L=12 mm

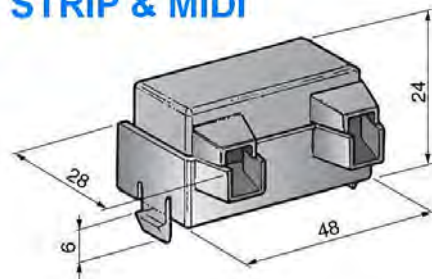
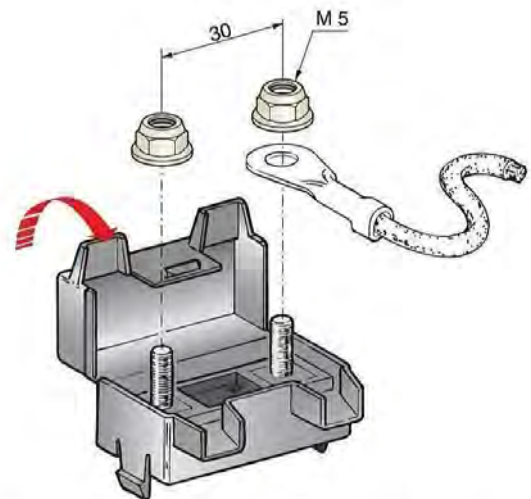
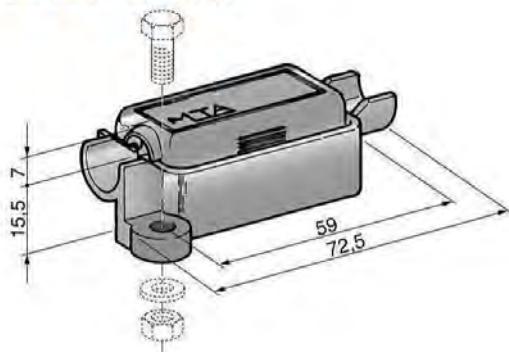
STRIP & MIDI

STRIP & MIDI

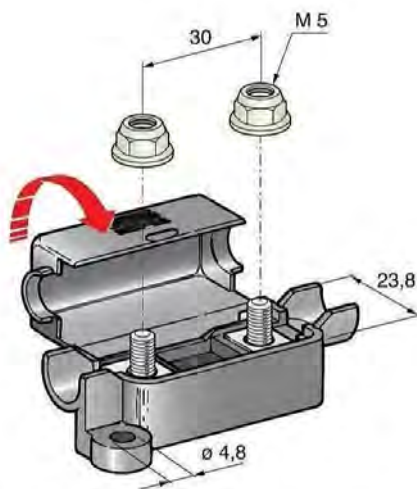
CODICE	DESCRIZIONE
0090100370	Portafusibile fissaggio a pressione

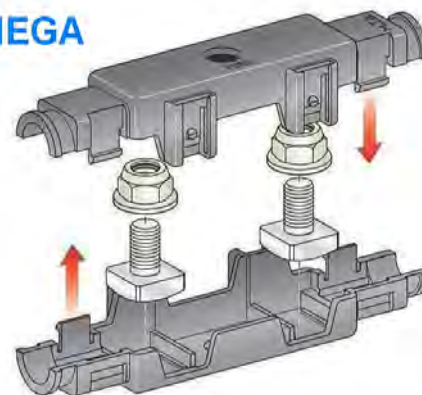

CODICE	DESCRIZIONE
0090100361	Portafusibile fissaggio a vite

MEGA

CODICE	DESCRIZIONE
0090100380	Portafusibile con viti e dadi

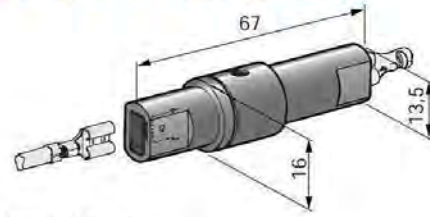
VETRO & BACHELITE

Chiusura a baionetta
Bayonet closing
Fermeture a baïonnette
Bajonettverschluß

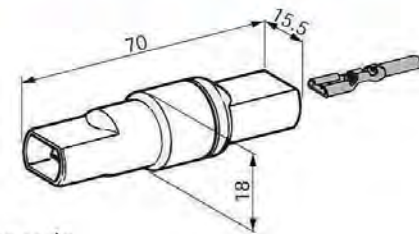

CODICE	DESCRIZIONE
0090100303	Con fusibile cilindrico nero 8A
0090100308	Con fusibile cilindrico marrone 25A
0090300305	Senza fusibile

VETRO & BACHELITE

Chiusura a vite
Screw closing
Fermeture a vis
Schraubverschluß

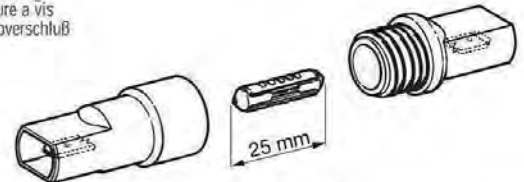

CODICE	DESCRIZIONE
0090100304	Con fusibile cilindrico nero 8A

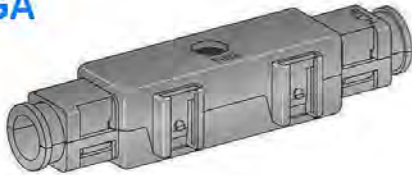
MEGA
KIT

CODICE	DESCRIZIONE
0090100380	Kit portafusibile + viti, dadi e terminali

VETRO & BACHELITE

Chiusura a baionetta
Bayonet closing
Fermeture a baïonnette
Bajonettverschluß

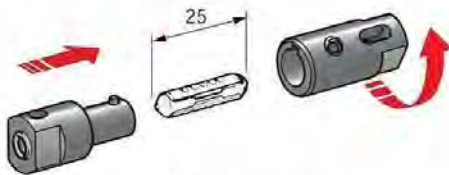
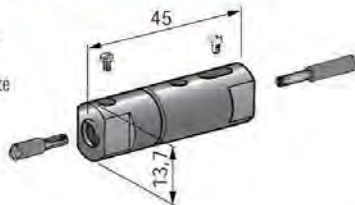

CODICE	DESCRIZIONE
0090100300	Con fusibile cilindrico nero 8A
0090350002	Con fusibile cilindrico verde 16A
0090100306	Senza fusibile

VETRO & BACHELITE

Chiusura a baionetta
Bayonet closing
Fermeture a baïonnette
Bajonettverschluß

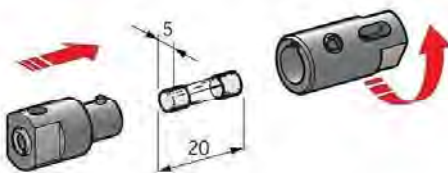
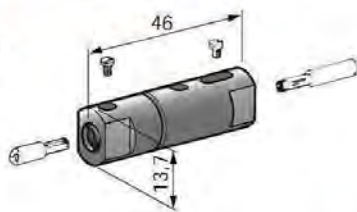

CODICE	DESCRIZIONE
0090100306	Con fusibile in vetro

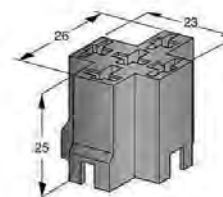
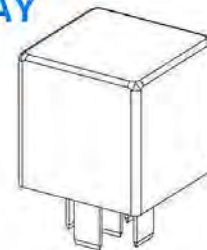
RELAY

CODICE	DESCRIZIONE
0094410246	Porta mini relé

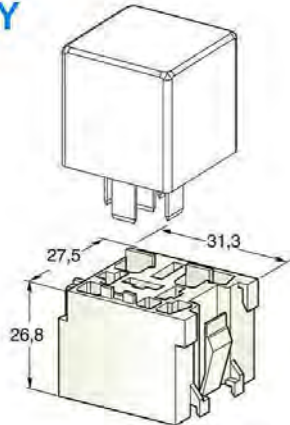
RELAY

CODICE	DESCRIZIONE
0094410245	Porta mini relè

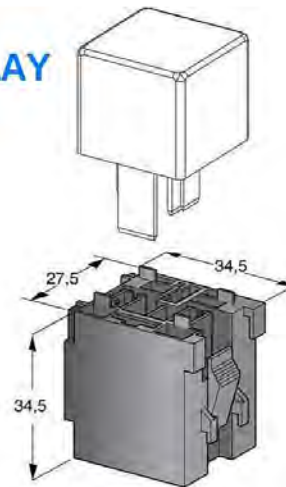
RELAY

CODICE	DESCRIZIONE
0094410247	Porta mini relè

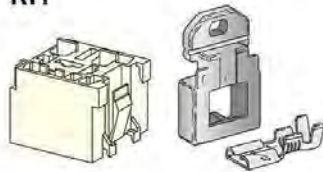
RELAY KIT

CODICE	DESCRIZIONE
0093050135	Kit portarelay+Terminali+Piastrina

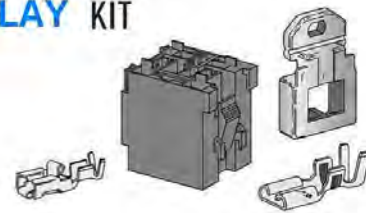
RELAY KIT

CODICE	DESCRIZIONE
0093050136	Kit portarelay+Terminali+Piastrina